

Operations Manual for Propeller-Washed Bead Filters

(PBF Model Series)

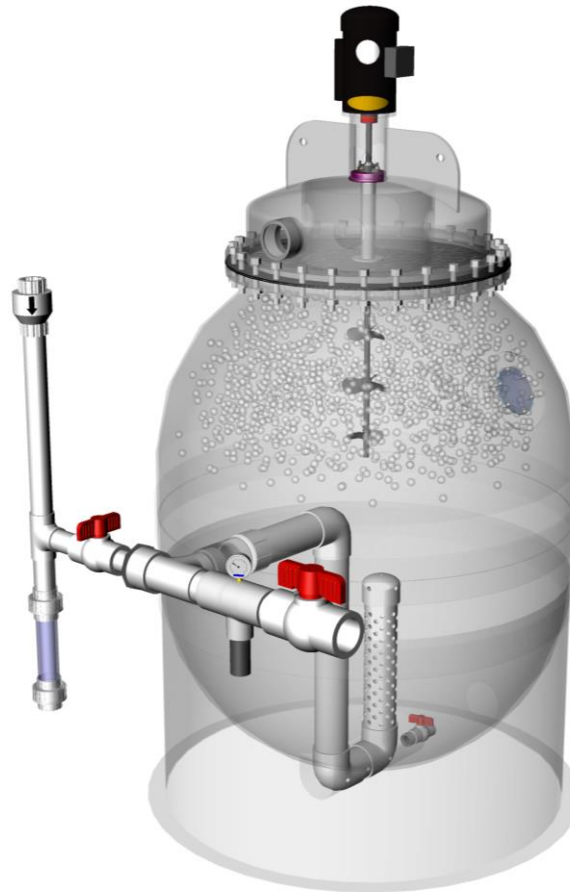

For your records please complete the following before sending in your warranty card to validate your warranty (Page-55):

Filter Model: _____

Filter Serial #: _____

Date Purchased: _____

AQUACULTURE SYSTEMS TECHNOLOGIES, LLC

108 Industrial Ave. Jefferson, LA 70121

P.O. Box 15827 New Orleans, Louisiana 70175

Toll Free: (800) 939-3659

Office: (504) 837-5575

Fax: (504) 837-5585

Info@BeadFilters.com

www.BeadFilters.com

Version08.A
Updated March 2008

Table of Contents

	Page
1.0 General Description	1
1.1 Overview	1
1.2 Parts Identification	2
2.0 Installation	8
2.1 Typical Treatment Configurations	8
2.2 Pump Selection	9
2.3 Plumbing	10
2.3.1 Filter Inlet Fittings	11
3.0 Routine Operation	14
3.0a Basic “SOP” Backwashing Procedures for Propeller-washed Bead Filters	14
3.1 Operational Sequences.....	15
3.1.1 Filtration Mode	15
3.1.2 Backwashing	16
3.1.3 Settling	17
3.1.4 Sludge Removal	18
3.2 Clarification	19
3.3 Biofiltration	21
3.3.1 Acclimation	22
3.3.2 Determining the Mass of Ammonium Chloride (NH ₄ Cl) required to get a 1-ppm (or 1 mg/L) Total Ammonia Nitrogen concentration (TAN or NH ₄ ⁺ -N) in 100 gals of water	26
3.3.3 Determining the Mass of Sodium Nitrite (NaNO ₂) required to get a 1-ppm (or 1 mg/L) Nitrite Nitrogen concentration (NO ₂ ⁻ -N) in 100 gals of water	26
4.0 Optimizing Nitrification	27
4.1 Areal Nitrification Rates	27
4.2 Sample Calculations	29
4.3 Discussion	30
4.3.1 Water Quality	31
4.3.2 Biofilm Management	31
4.3.3 Nutrient Transport	32
4.4 Optimization Procedures	33

Table of Contents (continued)

	Page
5.0 Trouble Shooting	35
6.0 Filter Specifications	38
7.0 Filter Maintenance	41
7.1 Special Maintenance Considerations	41
8.0 Glossary	42
9.0 References	44
10.0 Propeller-Washed Bead Filter Tech Tips.....	45
11.0 Propeller-Washed Bead Filter Automated Controller and Accessories.....	45
12.0 Propeller-Washed Bead Filter Options.....	48
13.0 Propeller-Washed Bead Filter Replacement Parts.....	49
14.0 Recommended Pumps for Propeller-Washed Bead Filters	51
15.0 Filter Warranty	55

List of Tables

	Page
1.1 PBF Series Filter Housing Parts Listing and Description	3
1.2 PBF Series Mixing Head Assembly Parts Listing and Description	5
1.3 PBF Series Parts Listing and Descriptions for the Diffuser Assembly	6
1.4 PBF Series External Plumbing Configuration Parts List	7
2.1 Things to Consider when Combining Bead Filters in Series with other Treatment Processes	9
2.2 Some General Rules for Plumbing a Bead Filter into a Recirculating System	
2.3 Plumbing Fittings for the Inlet Side of Filter	13
3.0a Baseline “SOP” for backwashing propeller-washed bead filters	15
3.1 The Four Operational Modes of the Propeller-washed Bead Filters	15
3.2 Mechanisms Contributing to the Capture of Solids in a Bead Filter	20
3.3 In the Biofiltration Mode, Bead Filters Cultivate Two Types of Bacteria which perform the Critical Biofiltration Function	22
3.4 Things You can do to Accelerate the Initial Acclimation of a Bead Filter	24
3.5 Things that Can be Done to Decrease Transitional Peaks of TAN and Nitrite When the Animal Density or Feed Rates are Increased	25
4.1 Water Quality Factors Impacting Nitrification in the Biofilter	27
4.2 Values of the Areal Ammonia Conversion Rate, C_A , that you should easily obtain for Different Loading Regimes	28
4.3 Sample Calculations of Performance Constants for a 6 Cubic Foot Bead Filter with a Specific Surface Area of $400 \text{ ft}^2/\text{ft}^3$	29
4.4 Things You Can Do to Enhance the Nitrification Rate of Your Bead Filter	33
4.5 Procedural Approach to Tuning a Propeller-washed Bead Filter for Optimum Nitrification	34
5.1 Trouble Shooting Guide	36
6.1 Dimensions and Specifications for the Standard PBF Model Bead Filters	39
6.2 Dimensions and Specifications for the “Special” or High Flow PBF Bead Filters.	40
7.1 Common Maintenance Procedures for Propeller-Washed Bead Filters.....	41

List of Figures

	Page
1.1 PBF Series External Configuration	1
1.2 PBF Series Housing Configuration (Front View)	3
1.3 Expanded View of the Mixing Head Assembly	4
1.4 Diffuser Assembly Details	5
1.5 External Plumbing Configuration Details and Assembly Diagram	6
2.1 Bead filters can be combined with other treatment units to meet a variety of water quality objectives	8
2.2 Propeller-washed Bead Filter (PBF) Pressurized Backwash Plumbing Scheme.....	10
2.3 Plumbing fittings sequence for the inlet side of a propeller-washed bead filter	11
2.4 Plumbing is simplified when the bead filter is operated on its own loop with a low head pump..	15
3.1 Most of the time the filter will operate in the filtration mode	16
3.2 The mixing motor is usually activated for less than one minute during the backwash cycle	17
3.3 During the settling step, the dislodged solids are allowed to settle for 5 to 10 minutes forming a concentrated slurry	18
3.4 Sludge is removed by opening the sludge valve. Water is normally drained until the effluent runs clear	19
3.5 Particle Size Removal Efficiency.....	20
3.6 The heterotrophic bacteria form a thin biofilm layer on each bead. The nitrifying bacteria compete with the heterotrophic bacteria for space	21
3.7 Two specialized types of nitrifying bacteria convert toxic Ammonia and Nitrite to the relatively safe Nitrate. Bicarbonate ions and oxygen are required in large amounts	23
3.8 TAN and Nitrite concentration build-ups are normally observed during the initial acclimation of a biofilter	24
4.1 Sampling ports should be added to the influent and effluent pipes to facilitate data collection	30
4.2 Biofilm management, good nutrient transport and favorable water quality enhance the nitrification	32
6.1 Filter Dimensions	38

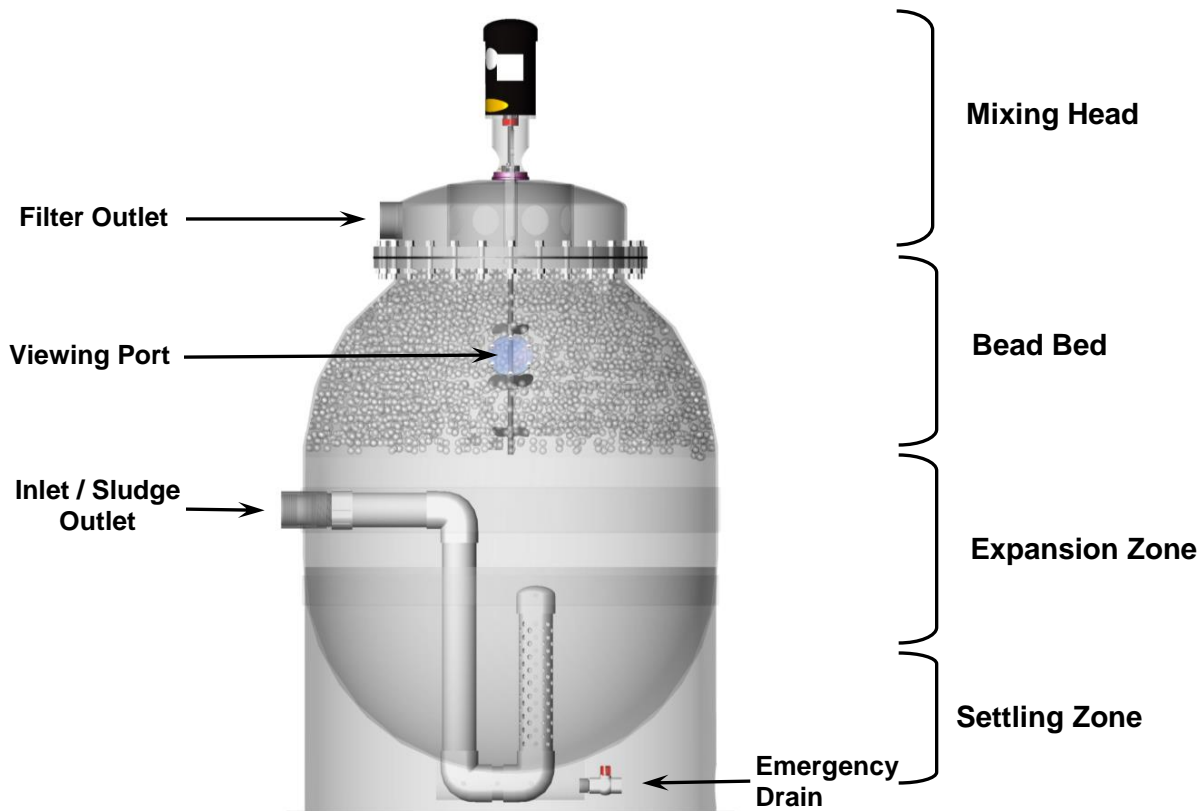

Figure 1.1 PBF Series External Configurations

1.0 General Description

1.1 Overview

Propeller-Washed Bead Filters were specifically designed to meet the need for water reconditioning in recirculating aquaculture systems. They are designed to provide a variety of functions required to allow the water to be reused for extended periods of time without accumulating harmful levels of suspended solids, dissolved organics or toxic nitrogenous compounds (i.e. ammonia or nitrite). Produced from excretion products of aquatic organisms, the amounts of these residuals are directly controlled by the feed rate.

Bead filters are classified as "Expandable Granular Biofilters" (EGB's) which means they are designed to function as a physical filtration device (or clarifier), removing solids, while simultaneously encouraging the growth of desirable bacteria which remove dissolved wastes from the water through the biofiltration process. The granular nature of the bead bed allows it to be cleaned, while providing large amounts of surface area for the bacteria to cling to. This permits large amounts of wastes to be treated using a relatively compact filter.

Propeller-Washed Bead Filters (PBF Series (Figure 1.1)) consist of a filtration bed of floating plastic beads in a configuration designed to facilitate simultaneous solids capture and biofiltration. Water enters the filter through a distribution manifold and passes upward through the packed bead bed where the physical and biological purification processes occur. Intermittent washing of the media by motor driven, embedded propellers facilitates the removal of captured solids and harvesting of biofloc. The washing operation is self-contained with separation of released solids occurring by sedimentation in an internal settling cone. Sludge is removed in a concentrated form, greatly reducing the waterloss associated with the washing process.

1.2 Parts Identification

The PBF Series filters (Figure 1.1) consist of a food-grade fiberglass filter housing, a fiberglass mixing head assembly, an inlet/sludge outlet manifold, and an emergency drain assembly. Tables 1.1 through 1.4 provide a complete parts listing, while Figures 1.2 through 1.5 illustrate the relationships between the various components.

FIBERGLASS CONSTRUCTION SPECIFICATIONS

Materials of Construction

Dion 6639 - T isophthalic
Type E Glass
C-veil Liner

Type of Construction

Hand lay-up all chop mat construction.

Construction Standard

NBS PS 15-69
ASTM 4095
ASTM C-582

Design Standards

Non-pressure part ASTM 4095 and NBS PS 15-69 where applicable.

Pressure part - Minimum thickness of shell and heads is designed to operate at 20 psi of internal pressure plus hydrostatic head were determined using formulas from ASME and include a 5:1 Safety Factor. All applicable safety factors are used.

The filter housing is designed to withstand low pressures (< 20 psi) and is equipped with an acrylic viewing port, which allows mixing efficiency to be examined. Internally, the filter housing (Figure 1.1) can be divided into three zones; the bead bed, the expansion zone, and the settling zone. The propeller assembly that is embedded in the bead bed is driven by the mixing motor. The mixing head assembly is built out of reinforced fiberglass to resist the torque induced by the powerful mixing motor and to stabilize the propeller shaft that rotates at approximately 1,750 rpm. The mixing head assembly (Figure 1.3) includes two mechanical seals (Figure 1.3, Part No. B.1.a) which provide a watertight seal where the propeller shaft penetrates into the vessel. Additionally, the thrust bearing (Figure 1.3, Part No. B.1.b) protects the mixing motor from damage, assuring an extended motor life.

The bead bed is contained by a stainless perforated screen (Figure 1.3, Part B.1.d) which is sandwiched between the head assembly flange (Figure 1.3, Part No. B.5.a) and the filter housing flange (Figure 1.2, Part No. A.1). The top propeller is positioned to assure the screen is vigorously scrubbed during each wash cycle. A single inlet/sludge outlet port is provided, allowing the flow through the diffuser (Figure 1.4, Part No. C.1) to be renewed during each washing cycle. The single port also circumvents most clogging problems within the inlet line. The External Plumbing (Figure 1.5) arrangement prevents accidental loss of beads during sludge removal. An emergency drain (Figure 1.2, Part No. A.4) is provided at the bottom of the cone to allow removal of all the beads and water.

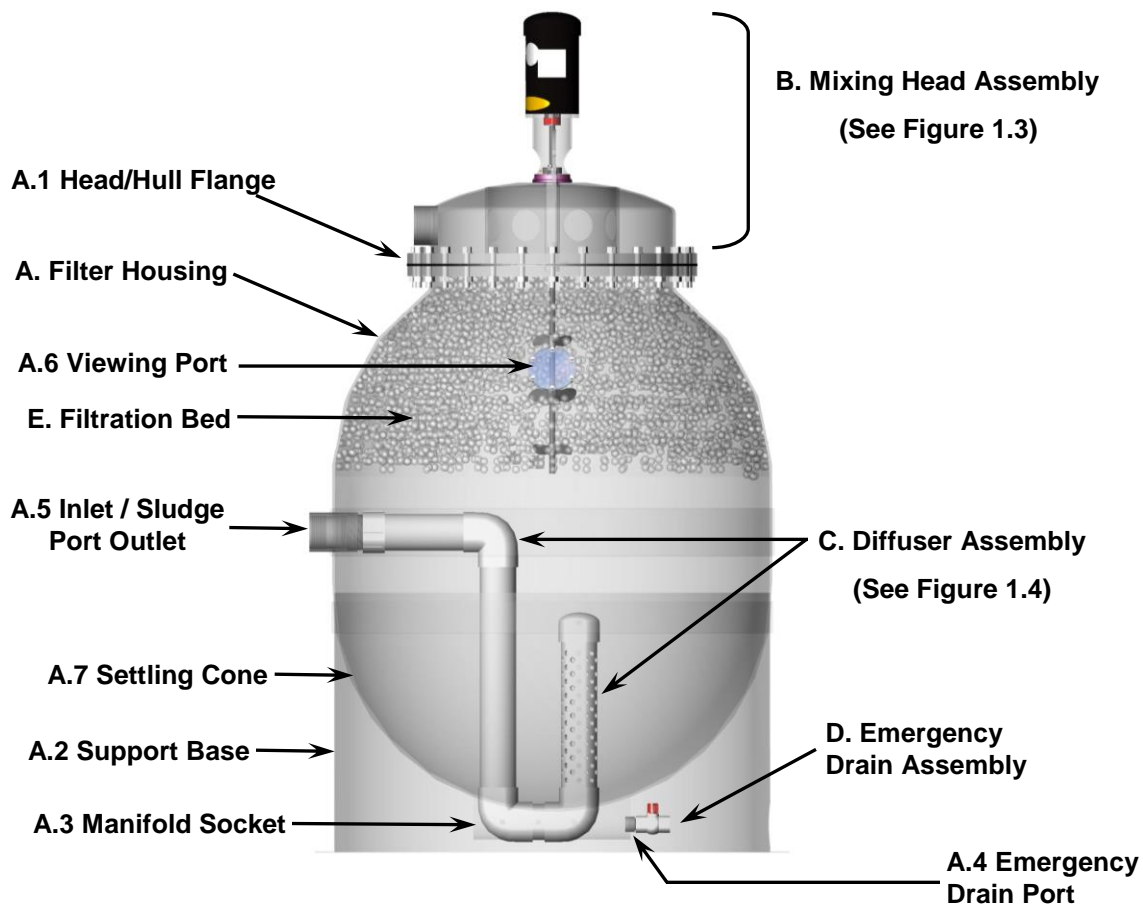

Figure 1.2 PBF Series Housing Configuration (Front View)

Table 1.1 PBF Series Filter Housing Parts Listing and Description

Number	Part	Function
A	Filter housing	Food grade fiberglass construction; PRESSURES MUST NOT EXCEED 20 PSI
A.1	Head/Hull Flange	Secures mixing head (B) and retaining screen (B.4) assemblies to Hull.
A.2	Support Base	Supports Filter Housing
A.3	Manifold Socket	Secures diffuser assembly (C).
A.4	Emergency Drain port	Unscreened outlet intended for filter drainage; use for sludge removal will result in loss of beads.
A.5	Inlet/Sludge Outlet port	Accommodates installation of diffuser assembly.
A.6	Viewing Port	Allows inspection of mixing regime during backwashing.
A.6.a	Acrylic View Plate	Not illustrated.
A.6.b	Neoprene Gasket	Not illustrated.
A.7	Settling Cone	Permits concentration of sludge prior to removal

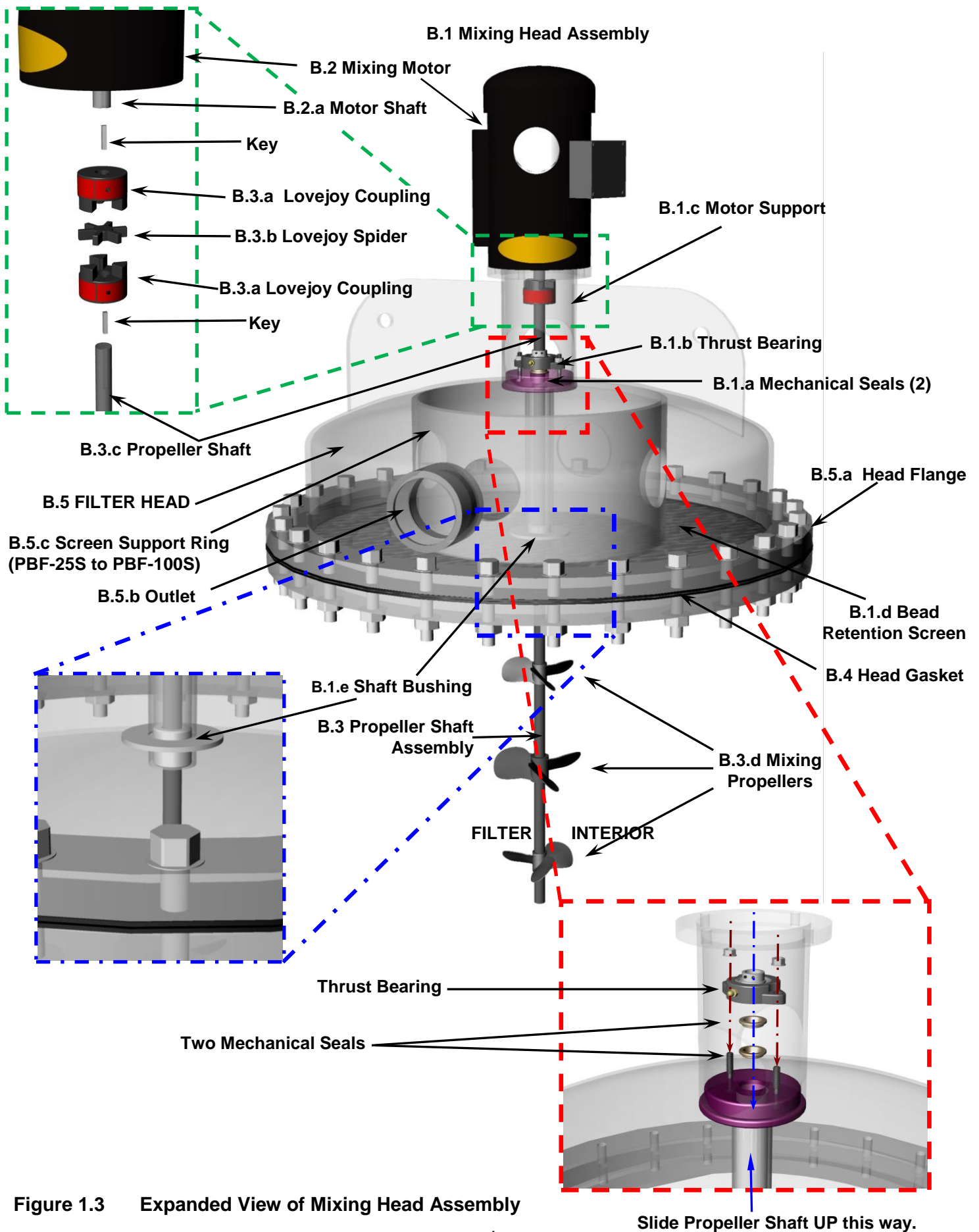

Figure 1.3 Expanded View of Mixing Head Assembly

Table 1.2 PBF Series Mixing Head Assembly Parts Listing and Description

Number	Part	Function
B.	Mixing head assembly	Facilitates bed fluidization during mixing operation.
B.1	Head assembly	Supports mixing motor/shaft; seals filter top.
B.1.a	Mechanical seal (2)	Seals propeller shaft.
B.1.b	Thrust bearing	Protects motor from propeller thrust.
B.1.c	Motor support	Supports and secures mixing motor.
B.1.d	Screen	Retains Beads.
B.1.e	Shaft bushing	Stabilizes propeller shaft.
B.2	Mixing motor	Powers propeller shaft.
B.3	Propeller Shaft Assembly	
B.3.a	Love-Joy Couplings (2)	Used to connect motor shaft to propeller shaft assembly.
B.3.b	Love-Joy Spider	Located between Love-Joys to reduce impact on Couplings when motor starts
B.3.c	Propeller Shaft	
B.3.d	Mixing Propellers	Agitates beads during cleaning cycle.
B.4	Head Gaskets (2)	
B.5	Filter Head	
B.5.a	Head Flange	Facilitates attaching head to filter hull.
B.5.b	Outlet Fitting	NPT threaded socket for effluent plumbing. Models PBF-50 and 100 have two (2) outlets orientated at 180 deg.
B.5.c	Screen Support Ring	For Model PBF-25S to PBF-100S

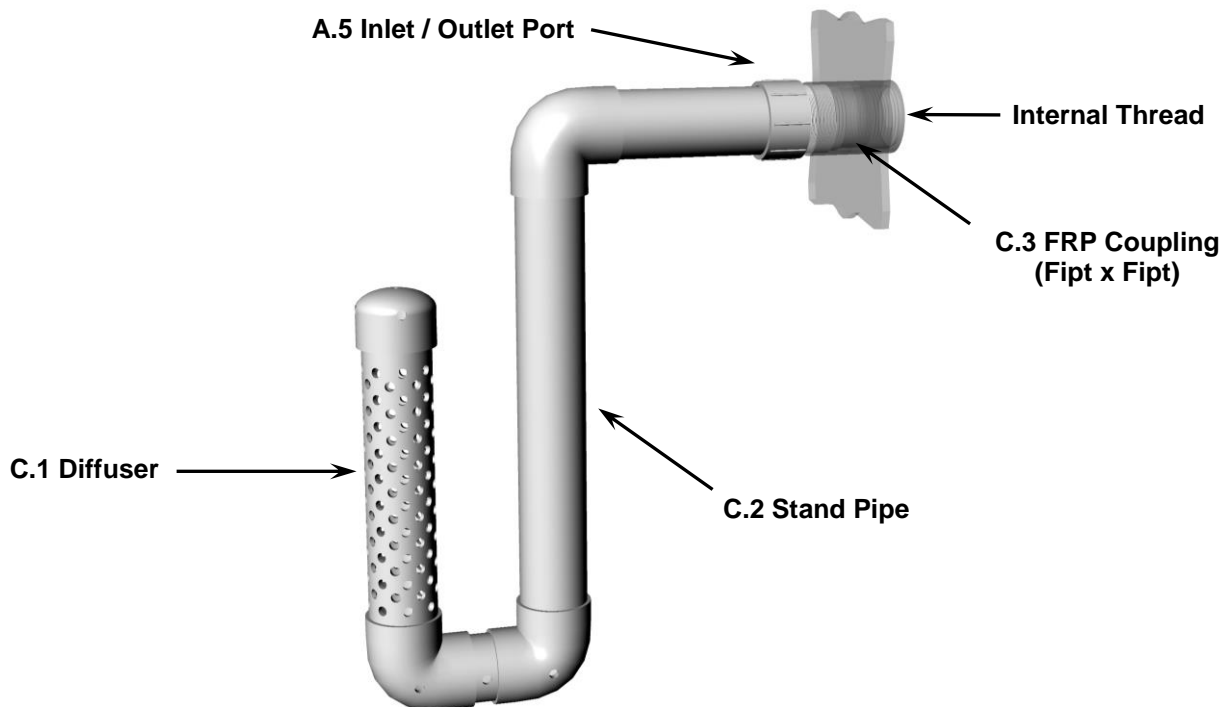

Figure 1.4 Diffuser Assembly Details

Table 1.3 PBF Series Parts Listing and Descriptions for the Diffuser Assembly

Number	Part	Function
C	Diffuser assembly	
C.1	Diffuser	Distributes flow beneath bead bed.
C.2	Stand pipe	Prevents bead loss during sludge removal.
C.3	FRP Coupling	Provides threaded connection on the inside for connecting diffuser assembly and outside of the filter hull for connecting external plumbing.

The External Plumbing Scheme (Figure 1.5) is designed to prevent bead loss during sludge removal. If the Sludge Drain Valve (Figure 1.5, Part D) is accidentally left open, the water level in the filter cannot drain below the inlet/sludge outlet coupling in the side of the filter hull provided the siphon break (Figure 1.5, Part A) is installed properly. The siphon break prevents siphoning of water level in the filter below inlet/sludge outlet.

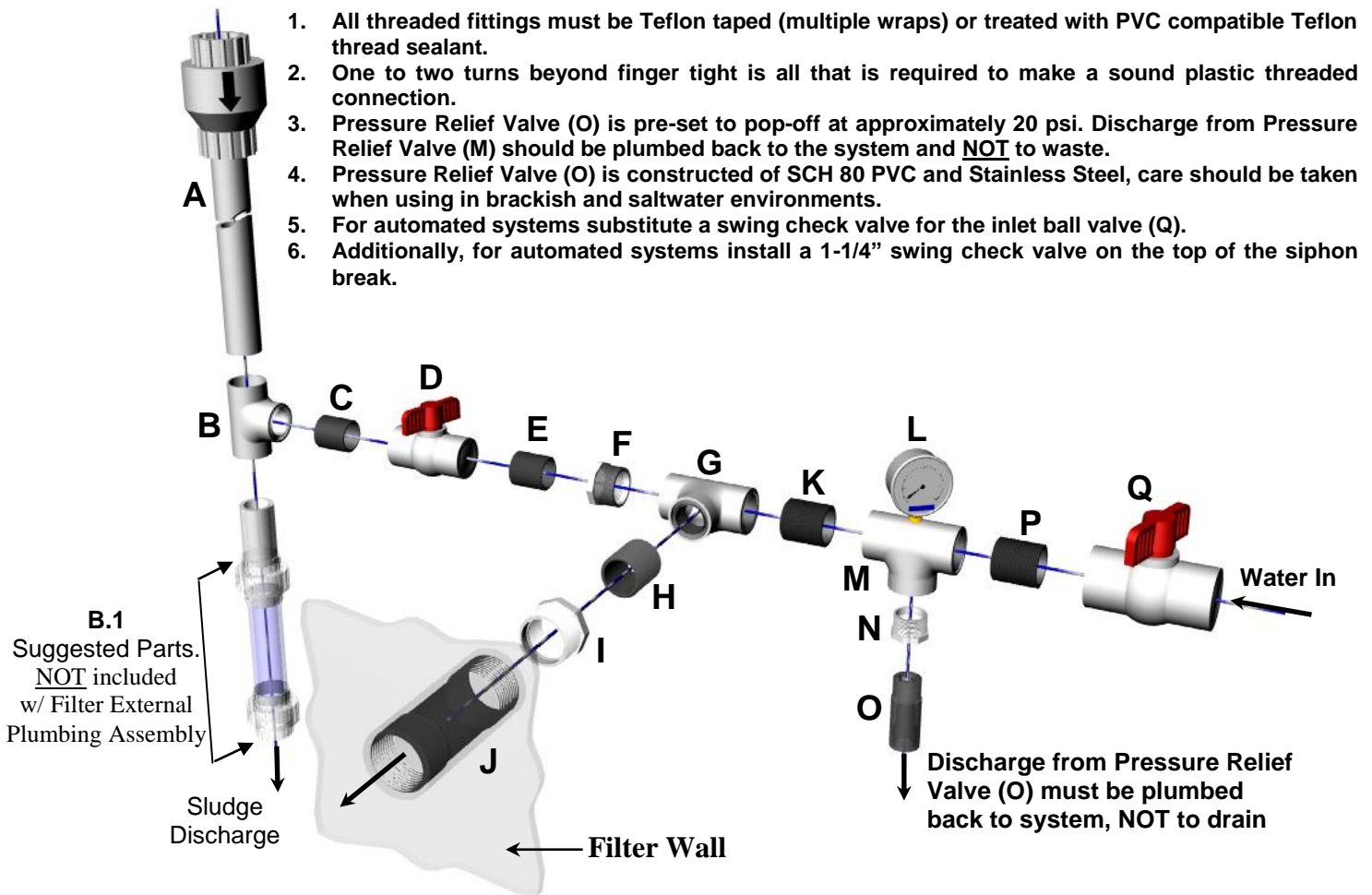

Figure 1.5 External Plumbing Configuration Details and Assembly Diagram

Table 1.4 PBF Series External Plumbing Configuration Parts List. (All parts list are supplied with filter as standard equipment unless other wise specified. All PVC parts are Schedule 40 unless otherwise specified.)

	Descriptions	PBF-3	PBF-5	PBF-10 & PBF-5S	PBF-25 & PBF-10S	PBF-50* & PBF25S*	PBF-100*
A	Sludge Discharge Siphon Break (24" Minimum Length)	N/A	1 1/4"	1 1/4"	1 1/4"	N-S	N-S
B	PVC Tee (s x s x t), facilitates installation of siphon break and sludge discharge line.	N/A	1 1/4"	1 1/4"	1 1/4"	N-S	N-S
B.1	Short section of CLEAR PVC should be installed on the discharge side to determine discharge clarity.	N-S	N-S	N-S	N-S	N-S	N-S
C	Schedule 80 PVC Close Nipple	N/A	1 1/4"	1 1/4"	1 1/4"	N-S	N-S
D	Sludge discharge valve. (PVC Ball Valve (t x t)).	1"	1 1/4"	1 1/4"	1 1/4"	N-S	N-S
E	Schedule 80 PVC Close Nipple	N/A	1 1/4"	1 1/4"	1 1/4"	N-S	N-S
F	Reducer Bushing (t x t).	N/A	1-1/2" x 1-1/4"	2" x 1-1/4"	3" x 1 1/4" (s x t)	N-S	N-S
G	Tee (t x t x t) except PBF-10S & 25 (s x s x t)	N/A	1 1/2"	2"	3"	N-S	N-S
H	Schedule 80 PVC Close Nipple	N/A	1 1/2"	2"	3"	N-S	N-S
I	Reducer Bushing (t x t).	N/A	2" x 1 1/2"	NA	NA	N-S	N-S
J	Filter Tank Connection Point (Fipt)	N/A	2"	2"	3"	4"	6"
K	Schedule 80 PVC Close Nipple or SCH 40 PVC Pipe	N/A	1 1/2"	2"	3"	N-S	N-S
L	Pressure Gauge (Reads PSI)	2" (0-15)	2 1/2" dia. (0-30)	2 1/2" dia. (0-30)	2 1/2" dia. (0-30)	N-S	N-S
M	Tee (t x t x t) except PBF-10S & 25 Reducing Tee (s x s x s)	N/A	1 1/2"	2"	3" x 3"x 1-1/4"	N-S	N-S
N	Reducer Bushing (t x t) except PBF-10S & 25 (s x t).	N/A	1 1/2" x 3/4"	2" x 3/4"	N/A	N-S	N-S
O	Pressure Relief Valve. PVC & 316 SS construction. Pre-set 20 psi.	N/A	3/4"	3/4"	1"	N-S	N-S
P	Schedule 80 PVC Close Nipple or SCH 40 PVC Pipe	N/A	1 1/2"	2"	3"	N-S	N-S
Q	Inlet valve. (PVC Ball Valve (t x t)).	1 1/2"	1 1/2"	2"	3"	N-S	N-S

* Available as an option, call for pricing.

N/A: Not applicable to particular filter model.

N-S: Not supplied with filter as standard equipment. Drawing showing recommended plumbing should be loose in the manual.

Note: External Plumbing on Model PBF-3 differs substantially from other filter models. Model PBF-3 shipped with plumbing pre-assembled and installed. Drawing showing recommended plumbing should be loose in the manual.

2.0 Installation

2.1 Typical Treatment Configurations

Bead filters are very versatile and can be used with a variety of other treatment processes. The pressure limits on the filter housing preclude the connection of bead filters ahead of devices such as heat exchanger, which must be driven at high pressures (Table 2.1).

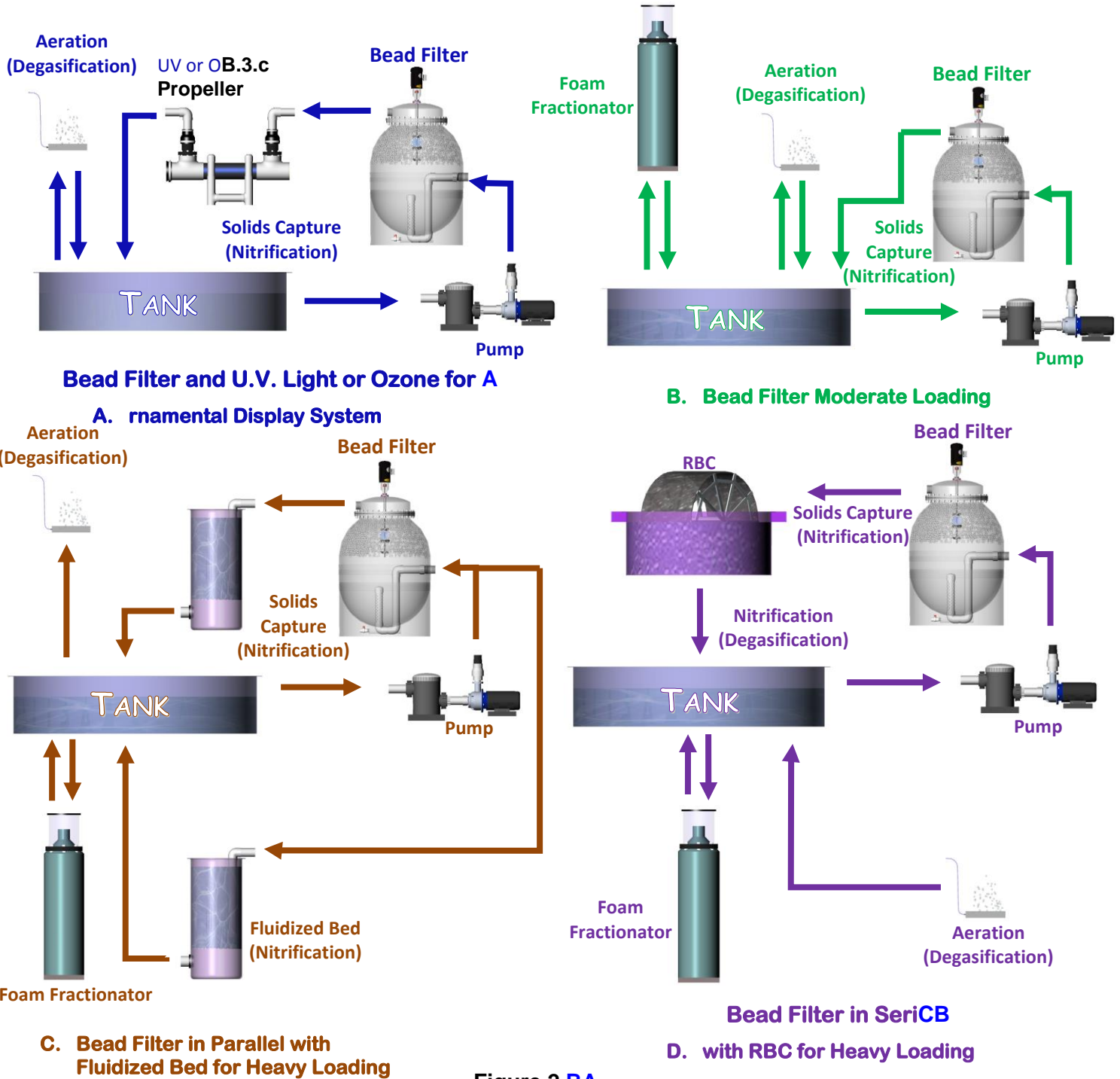

Figure 2.BA

Bead Filters can be combined with other treatment units to meet a variety of water quality

However, serial treatment is compatible with low head devices (biofilters, packed columns, U.V. lights), which are not particularly sensitive to the minor flow declines that occur towards the end of the filtration cycle. Parallel treatment is used to alleviate concerns about pressure build-up, flow variation, or oxygen depletion. As a general observation, systems configured with the major treatment processes in parallel are easier to manage. Each process can be optimized on its own flow loop without constraint from serially connected devices. Traditional wastewater treatment philosophies, which dictate sequential operations, have little validity in a recirculating system where the animals live on the influent (intake) side of the filter. Recirculation rates dictated by TAN (total ammonia nitrogen) and oxygen mixing constraints are generally so high that the order of treatment has little relevance. The principle disadvantage of parallel treatment is the higher flowrates required. Part of this problem can be offset by selecting a pump that will operate efficiently at the lower pressures that generally result from adoption of parallel treatment loops.

Figure 2.1 illustrates several commonly used bead treatment configurations. Bead filters are often used on ornamental fish systems where loading regimes are light (below about 0.50 lbs. of feed per cubic foot of beads per day). U.V. Sterilizers are often placed after the bead filter to provide for disease control (Figure 2.1.A). The addition of U.V. Sterilizers to pond treatment systems will also effectively control blooms of single celled algae. For moderate loading regimes (up to about 1.0 lbs. feed/ft³ of beads per day), the bead filter will provide excellent clarification and biofiltration by itself (Figure 2.1.B). The returning flow from the bead filter may not provide sufficient aeration for the system, so provisions for aeration and carbon dioxide stripping by blown air are required. In some cases, the feed will contribute to a foaming problem; so foam fractionation may also be required.

As the loading increases (above 1.5 lbs. feed/ft³ of beads per day), it becomes necessary to provide supplemental nitrification as the bead filter's clarification burden increases. Three commonly selected biofilters for supplemental nitrification are the fluidized bed, the rotating biological contactor (RBC) and Moving Bed Bioreactors (MBBR). Fluidized beds are best operated in parallel with the bead filters (Figures 2.1.C) to facilitate flow regulation & oxygen supplies; but, they can also be installed in a serial configuration. This powerful combination can produce tremendous amounts of CO₂. High CO₂ levels can drive down the pH, adversely impacting nitrification, so a packed column degasification unit is often installed after the bead filter. The packed column unit may not be required when the bead filter is placed in series with an RBC (Figure 2.1.D) or with MBBR. Both the RBC and MBBRs display excellent gas exchange characteristics, contributing strongly to carbon dioxide control.

Table 2.1 Things to Consider when Combining Bead Filters in Series with other Treatment Processes.

Parameter	Comments
Pressure	The PBF series filters have a maximum hull pressure of 20psi . Do not put devices, which create backpressures on the discharge side of the filter.
Flow	Flow rates through a bead filter may decline as the filtration cycle proceeds. Do not put flow sensitive devices downstream of the bead filter. Flow rates will be interrupted during the backwash cycle. Provide piping for a bypass_line to avoid flow disruption to downstream units. (See Details of a Pressurized Sludge/Backwash installation in Figure 2.2). After backwashing, when flow is resumed through the filter, it is common to get a flow of dirty water lasting several seconds from the outlet port.
Oxygen	Under a heavy loading and low flowrate conditions, dissolved oxygen concentrations can drop 3-4 mg/l as water passes through a bead filter. Do not put a submerged biofilter downstream without re-aerating.

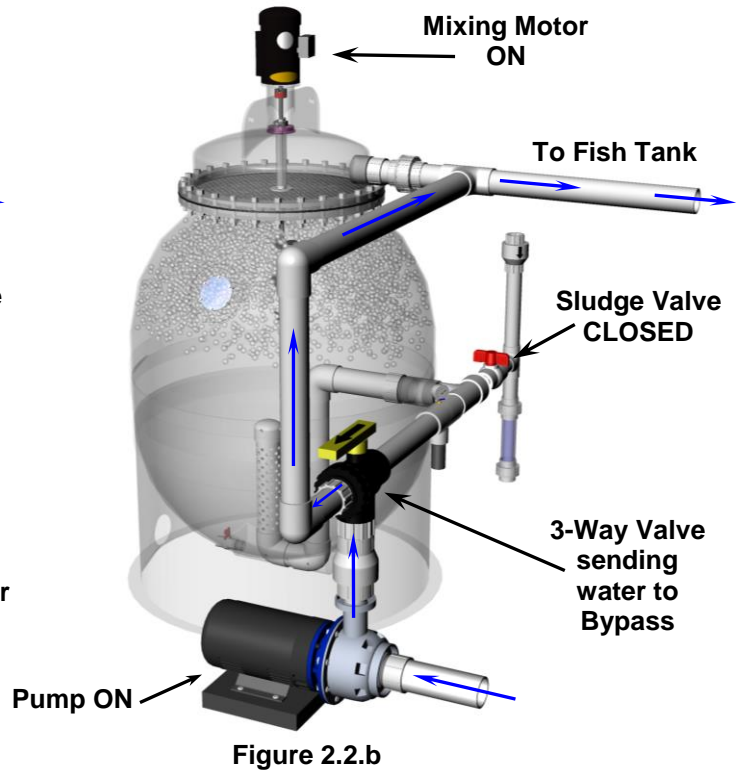
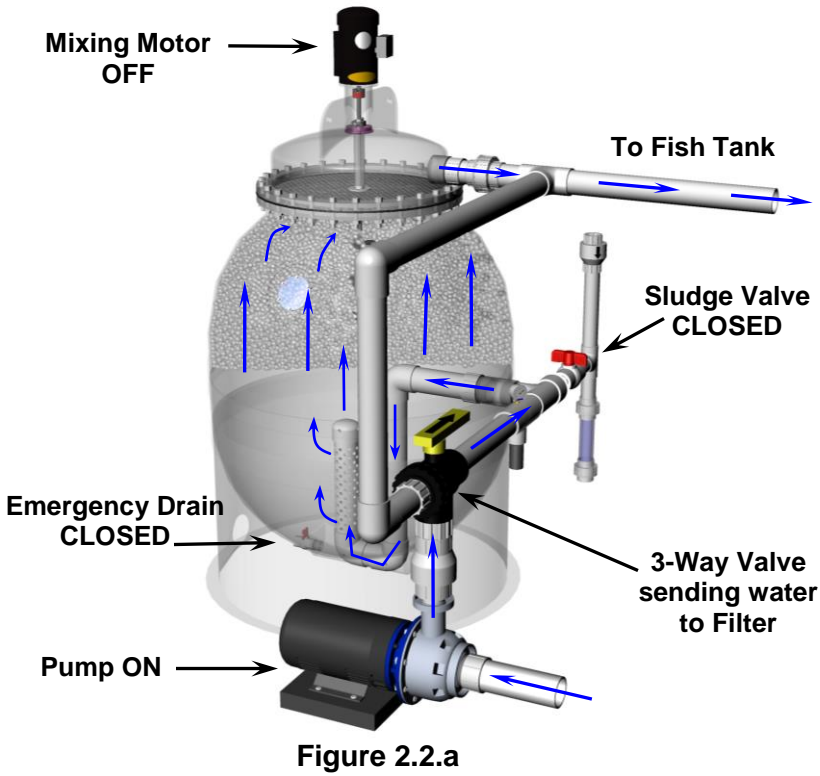

Fig. 2.2.a Normal Operation: Filtering

Fig. 2.2.b Backwash:

- ❖ Water bypasses beadfilter via the 3-Way Valve.
- ❖ Props active to fluidize beads.
- ❖ 10 Minutes settling time.

Fig. 2.2.c Pressurized Backwash:

- ❖ With 3-Way Valve still on bypass, the Sludge Backwash Valve is opened.
- ❖ Water enters backwards from the Bypass line, rinsing through the Bead bed.
- ❖ Pressurized bypass forces water through the Sludge Backwash Valve to discharge.
- ❖ Discharge pressure potential is equal to the bypass line pressure.
- ❖ No air enters the system.

Color coded arrows indicate directional flow

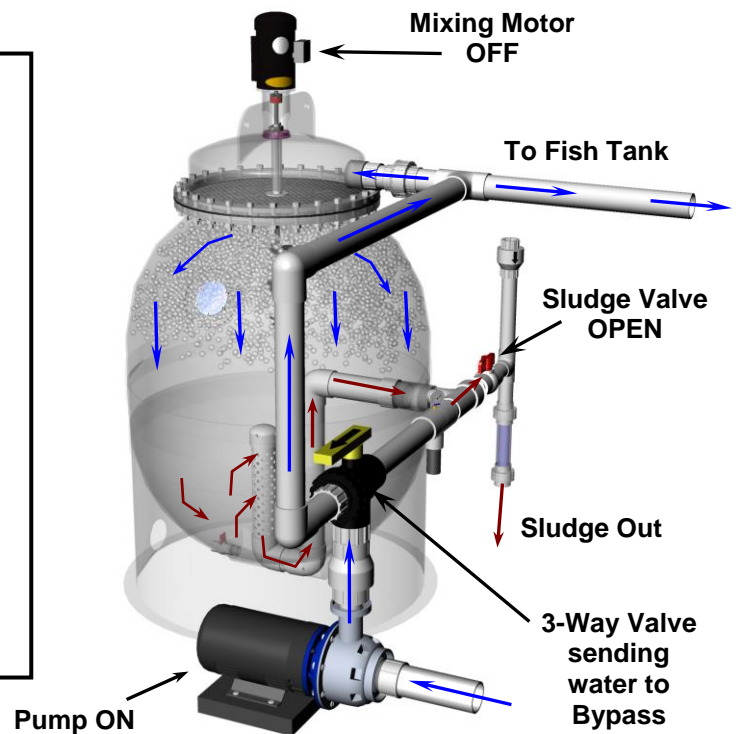

Figure 2.2 Propeller-washed Bead Filter (PBF) Pressurized Backwash Plumbing Scheme.

2.2 Pump Selection

Flow can be provided to the filter by any continuous duty centrifugal pump designed to deliver the desired flowrate at low to moderate pressures. Filters operated with clean beds at the maximum design flowrate typically display headlosses in the range of 2 to 4 psi depending on the exact plumbing configuration external to the filter. Backwashing is normally warranted when the headloss across the filter reaches 15 to 18 psi, reflecting the accumulation of solids and biofloc within the bed. Pumps must be selected to provide the desired flowrate at the peak filter headloss plus the headloss associated with the return piping system. Since the filter is not designed to operate as a pressurized vessel (**maximum hull pressure must remain below 20 psi**), attachment of other filtration, heating, cooling, or spray head devices, which generate backpressures, should be avoided on the outlet side of the filter. Generally, selection of a pump capable of delivering the maximum design flow at about 10-15 psi will prove satisfactory for most applications.

Perhaps the most critical aspect of the pump performance curve is the shut-off pressure. This is the maximum pressure the pump can generate when the discharge is closed off. The bead filters inherently accumulate solids as part of both their clarification and biofiltration functions. This leads to a gradual loss of hydraulic conductivity which is normally corrected by backwashing. If the solids load is unexpectedly high, or backflushing is discontinued, the filter bed will eventually clog. Correspondingly, the filter housing will be subject to the shut-off pressure of the pump. Thus, pumps with shut-off pressures in excess of 25-30 psi should be avoided, or the inlet side of the filter should be equipped with a pressure relief valve capable of venting water at the pump's delivery capacity at 20 psi.

Finally, the minimum operational pressure the pump will operate at should be examined. Some pumps are subject to overheating if run continuously at low pressures. It is very common for bead filters to operate at only 2 psi on the inlet side for extended periods. So a pump capable of operating at these low pressures should be selected or a valve capable of creating backpressure should be placed between the pump and the filter, allowing precise regulation of the pump pressures.

In summary, a continuous duty centrifugal pump rated to deliver the desired flow at about 10-15 psi should be selected. The pump must be able to accommodate the operational range of 2 - 15 psi. Pumps with high shut-off pressures (> 25-30 psi) or high minimum pressures (< 3 psi) should be avoided. The specification sheets (Section 6.0) provides information on flowrates and typical pump horsepower requirements for the various PBF models. Section 14.0 list pumps we recommend for use with our propeller-washed bead filters.

2.3. Plumbing

The day-to-day management of the bead filter will be made easier by proper installation and plumbing. Table 2.2 presents some general rules for installation that may prove helpful. Recirculating systems are generally plumbed with PVC piping and fittings. Metal fittings are generally avoided because of potential toxicity problems. Both copper and iron ions can be deadly to a wide variety of organisms. A limited number of brass fittings can be substituted for plastic in a variety of freshwater applications without apparent harm. But caution should always be used when introducing metal to a recirculating environment.

Although expensive, hard plastic unions generally pay for themselves late at night when the alarms have gone off and the pump or treatment component must be quickly taken off-line for servicing. Isolate all treatment components, including the pump and the intake manifolds with unions. Shut-off valves are also handy next to a union. It is amazing how much water can backflow or siphon through a union that had been loosened. Use of rubber couples (the kind consisting of a hard rubber tube and two hose clamps) on

pressure lines is a good way to pump your system dry late one night. Although these rubber couplers are handy and appear to be strong enough to handle moderate pressures, a little aging coupled with repeated exposures to water hammering will cause the rubber to crack or simply migrate off the end of your plastic pipe. Limit the use of the rubber couplers to gravity drain lines.

Table 2.2 Some General Rules for Plumbing a Bead Filter into a Recirculating System.

- Use PVC Schedule 40 Or 80 Fittings for All Pressurized Lines.
- Isolate the Filter and Pump with Hard Unions, Allowing For Quick Servicing.
- Never Use Copper or Galvanized Iron Fittings.
- Use Pressure Gauges Liberally.
- Do Not Use Rubber Couplings On The Pressure Side Of The Pump.
- Heavily Teflon Tape (Or Glue) Fittings On Suction Side Of Pump To Prevent Air Entrainment.
- **BEAD FILTER DISCHARGE AND SLUDGE LINES MUST HAVE AIR BREAKS.**
- **USE CHECK VALVES ON THE INLET LINE TO PREVENT BACKFLOW OF SLUDGES, LOSS OF PUMP PRIME AND/OR SIPHONING OF BEADS OUT OF FILTER DURING POWER OUTAGE.**
- Eliminate Or Minimize Lift On Suction Side Of Pump To Facilitate Priming And Increase Pumping Efficiency.
- Protect Pump And Treatment Units With In-Line Strainers.

From a management perspective, well-informed operating personnel make good decisions. With this in mind, each propeller-washed bead filter is equipped with a viewing window so that the mixing operation can be observed, monitored, and understood. The other two critical parameters that control the physical operation of a bead filter are flow and pressure. The bead filters should be plumbed so that the flowrate can be intermittently measured and continually observed. Additionally, pressure gauges should be placed to allow the discharge pressure of the pump and the pressure drop across the bead filter to be monitored.

One of the problems that plagues fish production systems is power failure. It is critical that the pumps run continuously and restart automatically in the event of a power failure. As a general rule, the pump should be placed as close to or below the waterline of its supply reservoir to minimize problems with priming. Also remember that centrifugal pumps rapidly lose efficiency as the lift on the suction side increases. Additionally, the pump should be protected against backflow by a check valve placed on its discharge. The check valve will keep the intake manifold full so the prime will not be lost and will prevent the backflow of sludge from your biofilters. Additionally, it will prevent **siphoning of beads into pump during power outage**. It does not take much material to jam a propeller and many pumps lack the starting torque required to initiate rotation when the propeller is jammed. In this same context, pumps should always be protected by an in-line strainer. Small fish, fish bones, claws, and other debris will quickly disable pumps and can wreak havoc on expensive treatment components.

When plumbing the PBF series filters, recognize that both the discharge and sludge removal lines must have air breaks. In the former case, air must be allowed to enter the filter housing when the sludge is removed. Otherwise, a vacuum will form and stop the flow. The air break in the sludge line is there to prevent accidental loss of beads by siphoning. The diffuser is not screened. Beads can readily backflow out of the filter if the water level is allowed to drop below the inlet/sludge outlet port. The siphon break must be plumbed in at the same elevation as the inlet/sludge outlet port.

Finally, recognize that bead filters are prone to bed disruption when bubbles are present in the inlet waters. Bubbles are generally the result of sloppy plumbing on the suction side of the pump. Heavily Teflon tape NPT fittings and securely glue slip fittings used in the construction of the intake manifold.

Additionally, make sure there are no air stones immediately adjacent to the pump intake.

2.3.1 Filter Inlet Fittings

Figure 2.3 illustrates the sequence of fittings typically used to plumb the intake side of a PBF filter in a recirculating system, while Table 2.3 summarizes the function of each fitting. Both the filter and the pump are equipped with hard unions, pressure gauges, and ball valves. The ball valves can be used to regulate flows and, if servicing is necessary, be used as shut-off valves to isolate the rest of the system. The inlet pressure gauge (Figure 2.3, No. 6) can be used to: (1) monitor pump performance, (2) measure the filter housing pressure which must be kept below 20 psi, and (3) estimate headloss across the filter bed when compared to the outlet pressure gauge. Additional protection for the bead filter and other treatment components on the bypass line can be provided by a pressure relief valve (Figure 2.3, No. 5), which can be set to release water back to the system if critical pressures are approached.

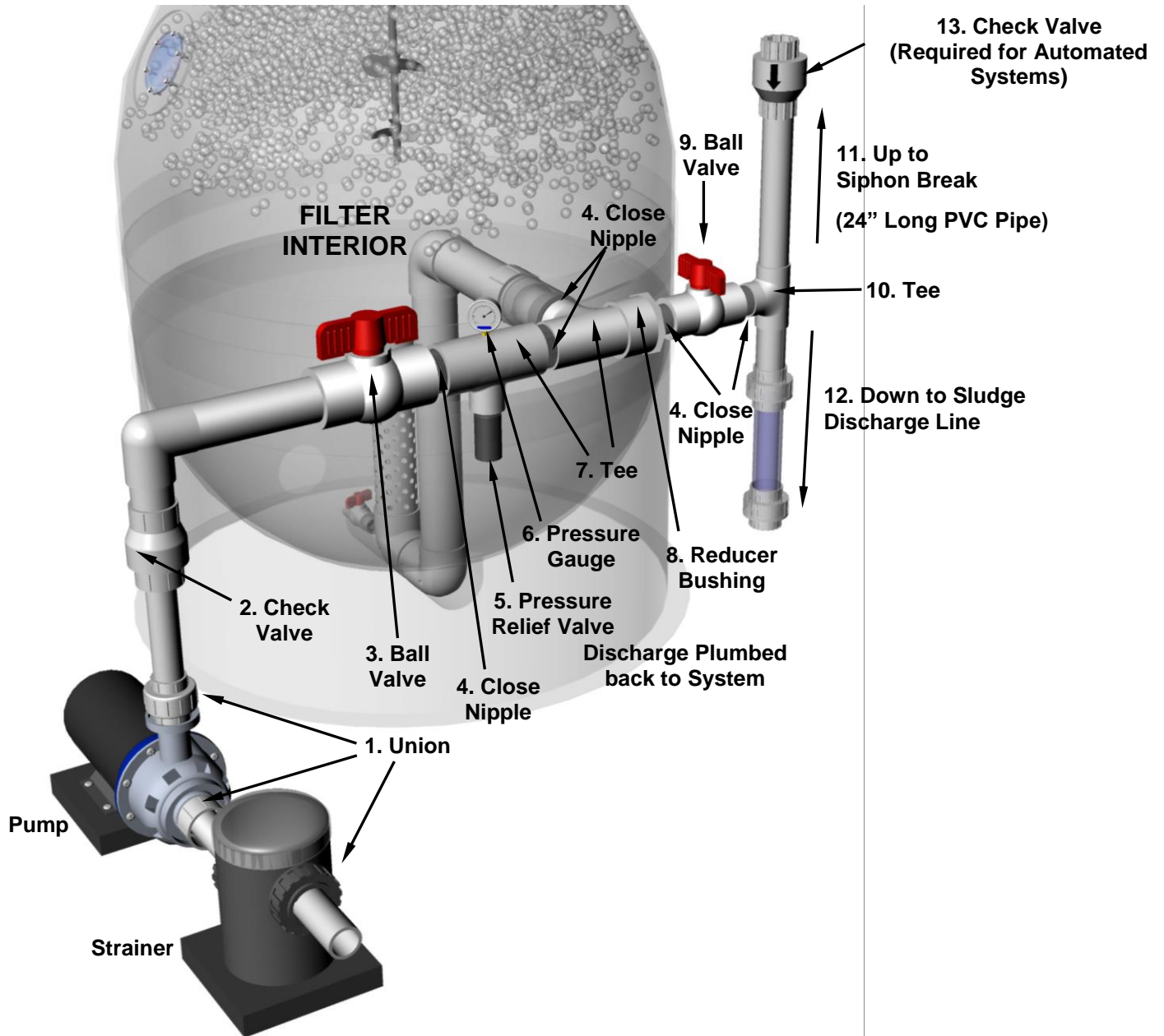

Figure 2.3 Plumbing fitting sequence for the inlet side of a propeller-washed bead filter.

During normal operation, ball valve (Figure 2.3, No.3) is opened (or partially closed to maintain minimum backpressure on the pump); the sludge release ball valve (Figure 2.3, No. 9) is closed. At the end of the backflush cycle, the filter valve (Figure 2.3, No. 3) is closed and the ball valve (Figure 2.3, No. 9) is fully opened, allowing the filter to drain by gravity to the sludge disposal pit or drain line. The tee (Figure 2.3, No. 10) that forms the base of the vertical stand pipe (Figure 2.3, No. 11) is at the same level as the inlet/sludge outlet port and provides the critical anti-siphon air break which prevents excessive drainage of the filter. The illustrated configuration also includes a short segment of clear PVC or acrylic pipe (Figure 2.3, No. 12) which is used to monitor the quality and quantity of sludge removed.

Figure 2.4 illustrates a simplified plumbing configuration, which can be used when the bead filter is on its own flow loop with a well-matched low head, centrifugal pump. The intake manifold illustrated consists of a segment of perforated PVC pipe (one-half inch holes) whose principle function is to sweep feces from the tank bottom without becoming fouled by debris or dead fish. For heavily loaded systems, it is a good idea to provide a clean-out plug to allow easy access to the pipe's interior, which can easily become coated with more than one-half inch of tough biofilm or Bryozoa colonies. A shut-off valve and unions facilitate quick servicing of both the pump and the intake manifold.

The plumbing on the intake side of the filter is simplified. Since throttling of the pump is not required, a single pressure gauge can serve to monitor both pump and filter performance. Pressure drops across the filter can be estimated from this gauge provided the discharge line losses are negligible and no siphoning occurs. The pump must be shut-off during backwashing, but is protected against backflow of sludges and loss of prime by a single check valve. The return line discharges above the water level, facilitating visual monitoring by system managers, while providing the air break required for sludge removal.

Table 2.3 Plumbing Fittings for the Inlet Side of Filter (Illustrated in Figure 2.3).

Number	Name	Function
1	Union	Allows for quick replacement of pump.
2	Check Valve	Prevents loss of pump prime and backflow of sludge when the pump is turned off. It also prevents siphoning of beads into pump during power outage.
3	Ball valve	Regulates Filter Flow, closed during backwash.
4	Close nipple	Facilitates connection between threaded fittings.
5	Pressure relief valve	Pressure relief valve must be used with pumps with high shut-off pressures (>20 psi); protects filter hull from rupturing. Discharge plumbed back to system and NOT to the drain/waste.
6	Pressure gauge	Used to monitor inlet pressure (hull pressure) for the filter; used as indicator of need to backwash at pressure > 15 psi.
7	Tee	
8	Reducer Bushing	
9	Ball valve	Normally closed; opened to permit sludge removal.
10	Tee	Diverts flow to sludge line during the sludge removal step. Facilitate installation of siphon break (upward) and sludge discharge line (downward).
11	Siphon Break	Mandatory vertical standpipe acts to break siphoning action when draining sludge and prevents accidental bead loss. The siphon break tee must be plumbed in at the same elevation as the inlet/sludge outlet port.
12	Clear pipe	Short segment (6 to 12 inches) of clear PVC acrylic pipe used to monitor the clarity of sludge during the sludge removal step.
12.a	Union (2)	Optional. Facilitates connection/removal and cleaning of the clear pipe segment.

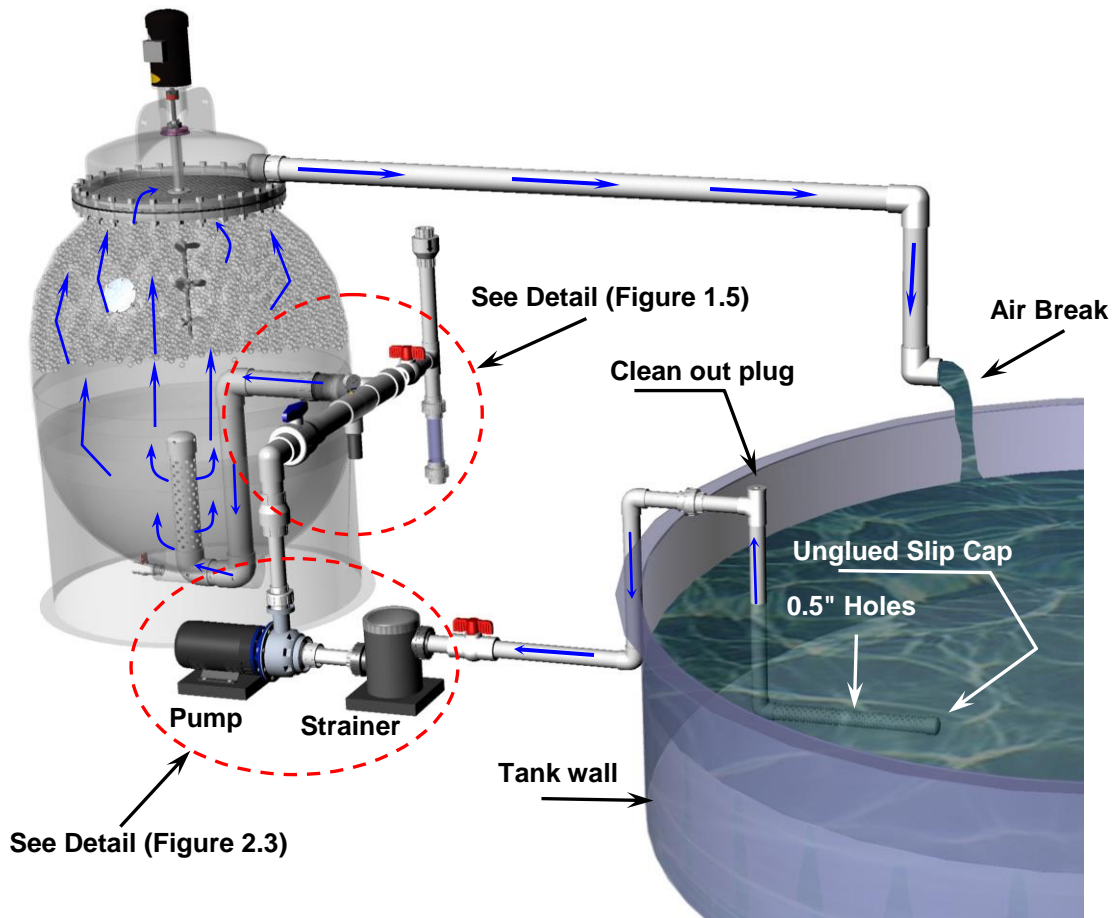

Figure 2.4 Plumbing is simplified when the bead filter is operated on its own loop with a low head pump.

3.0 Routine Operation

Bead filters can be operated as a biofilter, a clarifier or Bioclarifier performing both functions simultaneously. How the filter will perform is dependent on the wasteload, the presence of other unit processes in the treatment train, and management. One of the unique aspects of a bead filter is its ability to treat soluble and particulate wastes with a high organic content. These wastes tend to cause bacterial growth that can "gum-up" or clog many types of filters. Bead filters are designed to take advantage of this phenomenon, utilizing the bacteria cultured in the bead bed to enhance solids capture and to facilitate stabilization of dissolved wastes through the process of biofiltration. In this chapter, the basic operation of the filters is discussed (Section 3.1), followed by an overview of their clarification (Section 3.1) and biofiltration (Section 3.2) functions. The biofiltration section also describes procedures for acclimating the biofilter.

3.0a Basic "SOP" Backwashing Procedures for Propeller-washed Bead Filters

Table 3.0a delineates the "standard operating procedure" for backwashing propeller-washed bead filters operating in either a biofiltration/solids capture mode or a solids capture only mode.

Table 3.0a Baseline “SOP” for backwashing propeller-washed bead filters.

	Biofiltration/Solids Capture Mode	Solids Capture Only Mode
Backwash Frequency	24 to 48 hours depending on pressure (Do not exceed maximum hull pressure rating).	As dictated by pressure or once for every 2 to 4 pounds of feed per cubic foot of media pressure permitting.
Mixing Duration	Fluidization of the bead media as viewed in the window plus 3 to 5 seconds. Over-mixing can impact nitrification by scouring off beneficial bacteria.	Fluidization of the bead media as viewed in the window plus 30 seconds. Over mixing is not critical when operating in this mode since filter not being relied on for nitrification/biofiltration.
Settling Time	10 minutes	10 minutes
Sludge Discharge	Drain filter until water runs clear. Water loss will vary with feed rate and backwash frequency.	Drain filter until water runs clear. Water loss will vary with feed rate and backwash frequency.

3.1 Operational Sequences

The propeller-washed bead filters are operated in four sequential steps (or modes) to complete the operational cycle (Table 3.1). The Filtration is followed by Backwashing (mixing) and Settling operations which facilitate the final Sludge Removal process. Each of these modes of operation is described in the following paragraphs.

Table 3.1 The Four Operational Modes of the Propeller-washed Bead Filters

Mode	Objective	Duration (typical)
Filtration	Capture of suspended solids (TSS) Removal of dissolved organics (BOD) Nitrification	24 – 48 hours
Backwashing (Propeller run Time)	Avoids clogging of the bed by expansion and agitation of the bed, releasing captured solids and excessive biofloc.	< 1 minute
Settling	Concentration of released solids and biofloc into a slurry	10 minutes
Sludge Removal	Transport of sludge away from treated system	1 – 3 minutes

3.1.1 Filtration Mode

The filters are operated in the filtration mode most of the time (Figure 3.1). Filtration is accomplished by turning the pump on and opening the inlet valve. The sludge valve and emergency drain should be securely closed to prevent leakage and the mixing motor is OFF. The filter housing quickly fills with water from the pump and the bead bed floats up against the retaining screen until it forms a tightly packed filtration bed. As the recirculating waters pass through the bed, suspended solids are captured and the biofiltration processes are active. Pressures on the influent side of the filter should be noted at the beginning of the filtration cycle. The influent pressure should then be monitored during the filtration cycle to assure that the influent pressure does not exceed the 20 psi maximum hull pressure specified for the PBF series filters. Typically, the backwashing cycle is timed to correspond with influent pressures of about 15-18 psi (see Section 2.1).

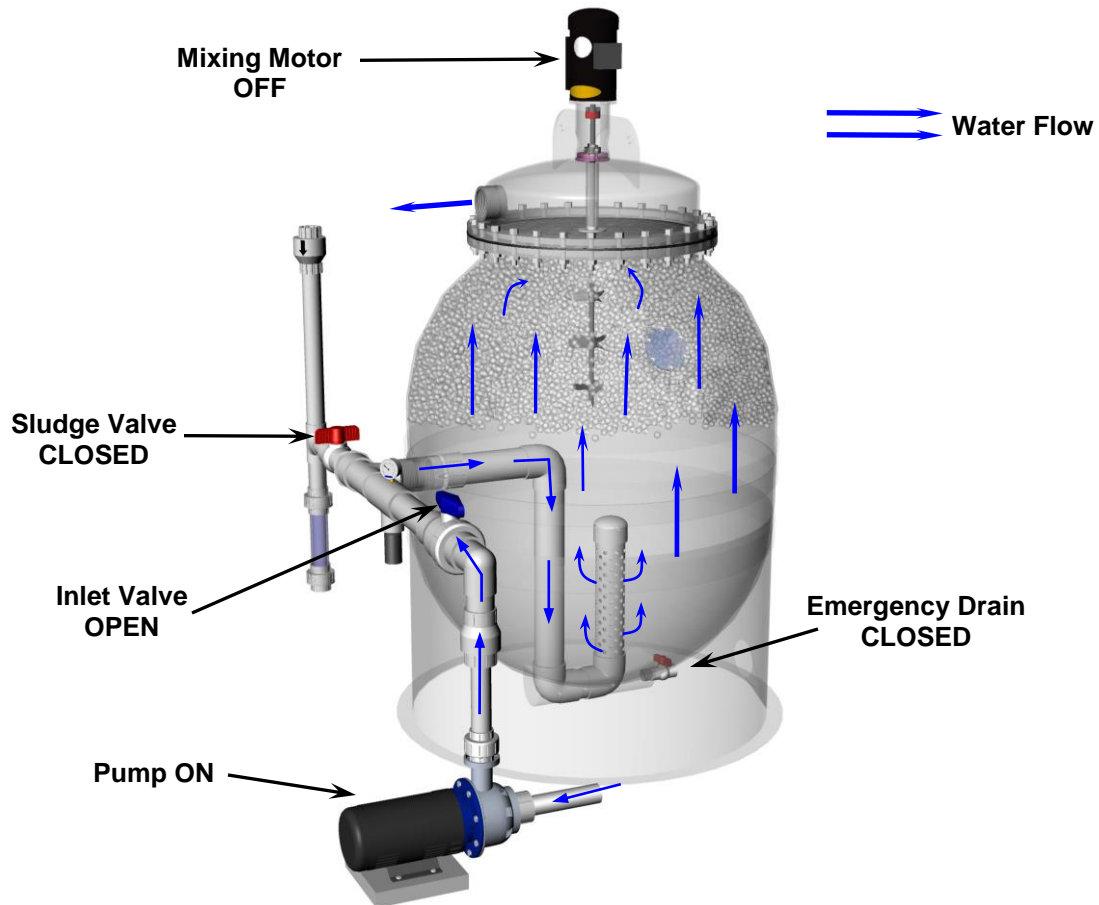

Figure 3.1 Most of the time the filter will operate in the filtration mode.

During the filtration cycle, the physical integrity of the packed bed should not be disturbed. The mixing motor must remain off. Activation of the mixing motor while the filter is under pressure will induce excessive compaction forces on the propeller blades, causing the mixing motor to overheat or draw excessive amperage. Disruption of the bed integrity can also occur by shutting the recirculating pump off and on or by sudden changes in system pressures caused by opening major valves in the system. Such point disruptions may cause the filter to release a cloud of sludge as the bed reforms. Air bubbles in the inlet waters must also be avoided. These bubbles are normally caused by leaky fittings on the suction side of the recirculation pump. Once the bubbles get into the filter hull they will cluster beneath the bead bed until they aggregate into a large bubble that will burst through the bed. Air bubbles will severely impair the ability of the filter to capture and hold fine solids. Consequently, this problem usually manifests itself as a chronic cloudy water condition.

3.1.2 Backwashing

Backwashing or cleaning of the bead bed (Figure 3.2) is accomplished by turning off the pump and/or closing the inlet valve and then activating the mixing motor. **CAUTION: Do not operate the mixing motor unless the filter is filled with water at least to the bead retention screen. Operating the filter with the water level below the screen may cause the bushing (part # B.1.e, page 4, Figure 1.3, Table 1.2) to melt and the shaft to seize.** The sludge valve and the emergency drain should remain closed. The mixing motor should rapidly reach high rpm's and the beads inside the viewing port should start to move slowly after about 5-10 seconds. Within 15-30 seconds the beads should be actively swirling. When operating as biofilter, it is important only to run the mixing motor long enough to fluidize beads plus 3-5 seconds and if operated for mechanical filtration, running the mixing motor to fluidize beads plus 30 seconds is sufficient.

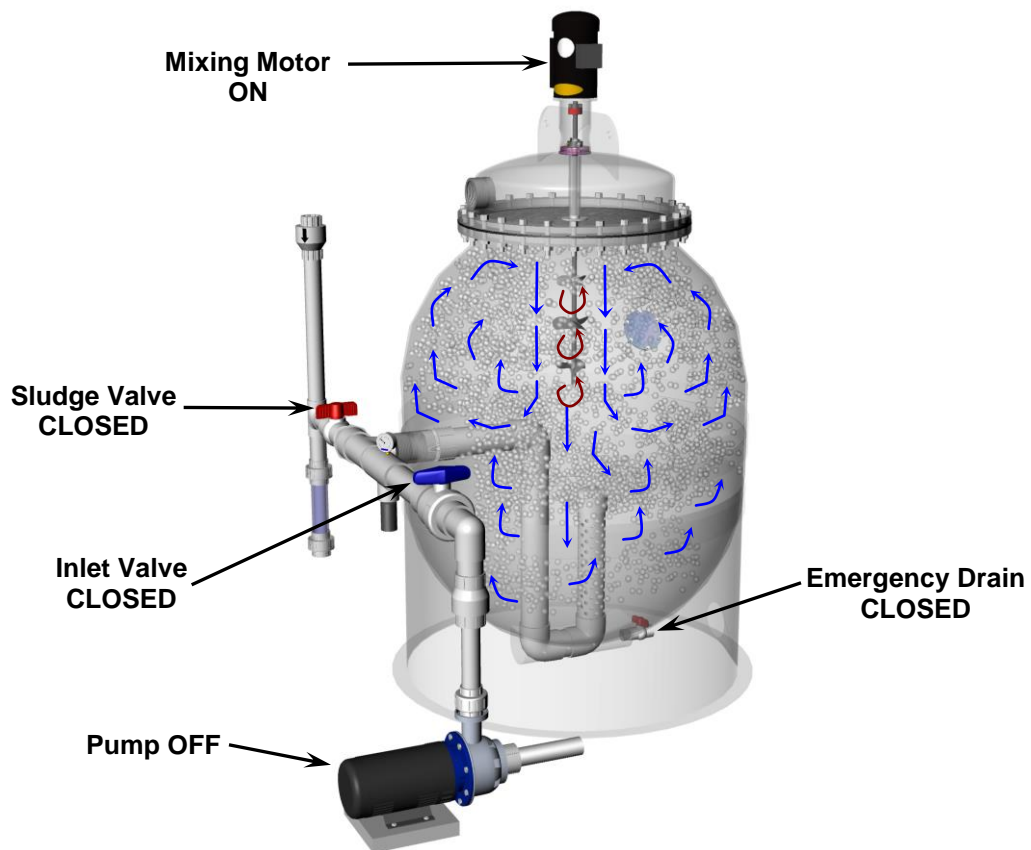

Figure 3.2 The mixing motor is usually activated for less than one minute during the backwash cycle.

The objective of the backwashing step is to release solids and excessive biofloc from the beads. This is accomplished by the hydraulic shear forces induced by the propellers as the beads are thrust downward into the expansion zone and by contact between the beads as they swirl upwards around the outside.

The propeller-washed bead filters are designed to input a lot of cleaning energy in a short period of time. Since most of the captured solids lie between the beads and the desirable biofloc is attached, excessive washing just damages the biofiltration performance without benefiting clarification. The duration of mixing should be limited so that the beads are not actively swirling in the viewing port for more than 5 seconds for optimum biofiltration and 30 seconds for mechanical filtration. Another variable controlling filter performance is the backwash frequency. Filters must be backwashed when accumulation of solids causes either high inlet pressures (> 10 psi) or reduced flows. Filters used strictly for clarification can be set to wash by timers or pressure triggers across a wide range without influencing performance as long as common sense is used. Backwashing intervals as little as 3 hours have been used for clarification in heavily loaded recirculating aquaculture applications. These high backwash frequencies, however, adversely impact nitrification rates; so filters must be more carefully monitored if optimization of biofiltration is desired (See Section 4.0). Filters operated for biofiltration are normally washed only once a day or once every other day.

3.1.3 Settling

Once the bed has been expanded and agitated for several seconds, the mixing motor is turned off and the Settling mode of operation is initiated (Figure 3.3). Typically, the filter is left idle for 10 minutes as the beads float upward reforming the filtration bed while the sludge sinks into the settling cone, forming a concentrated slurry. The particles released from the bed during the backwashing mode tend to be large and settle rapidly; so little benefit is gained by extending the settling period beyond 10 minutes.

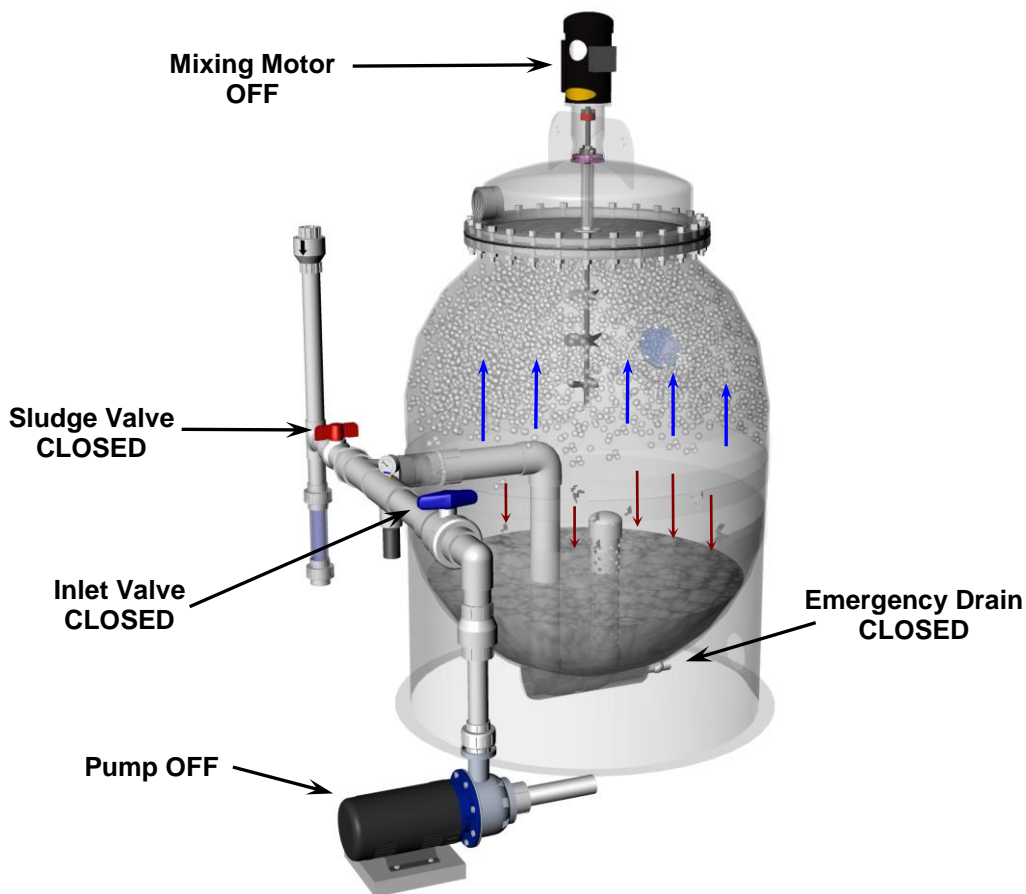

Figure 3.3 During settling, the solids dislodged during mixing are allowed to settle for 10 minutes forming concentrated slurry, while the beads float back up re-forming the filtration bed.

3.1.4 Sludge Removal

The final mode of operation is Sludge Removal (Figure 3.4). Sludge is removed by opening the sludge valve. The filter then drains by gravity, backwards through the diffuser assembly. The heavier sludge is pushed out ahead of the overlying waters. The anti-siphon standpipe allows air to enter the sludge drain line; thus, the filter cannot be drained below the inlet/sludge outlet port. The filter is designed to avoid bead loss at this water level. If you experience unexpected/unexplained loss of beads please refer to Section 5.0, Item 1, page 34. In most applications, settling is very effective and it is not necessary to drain the filter all the way to the inlet/sludge outlet port. Commonly, the sludge drain line is equipped with a clear segment of pipe that allows the clarity of the discharged water to be observed. As soon as the draining water appears to be as clear as the rearing tank's water, the sludge valve is closed. This approach greatly reduces water loss without impacting filter performance.

The emergency drain (Figure 1.2, Assembly D) must not be used for sludge removal. This outlet is not screened and is designed to facilitate bead removal. Bead loss will occur very rapidly if this drain is left open too long. The emergency drain line should only be used to drain the filter for servicing or to reduce weight if the filter must be moved. Proper draining of the filter requires that air enter the top of the filter through the outlet fittings (Figure 1.3, Part B.5.b). If the return (outlet) lines are submerged then the outlet line must be equipped with an anti-siphon check valve which will allow air to enter the filter when the sludge valve is opened.

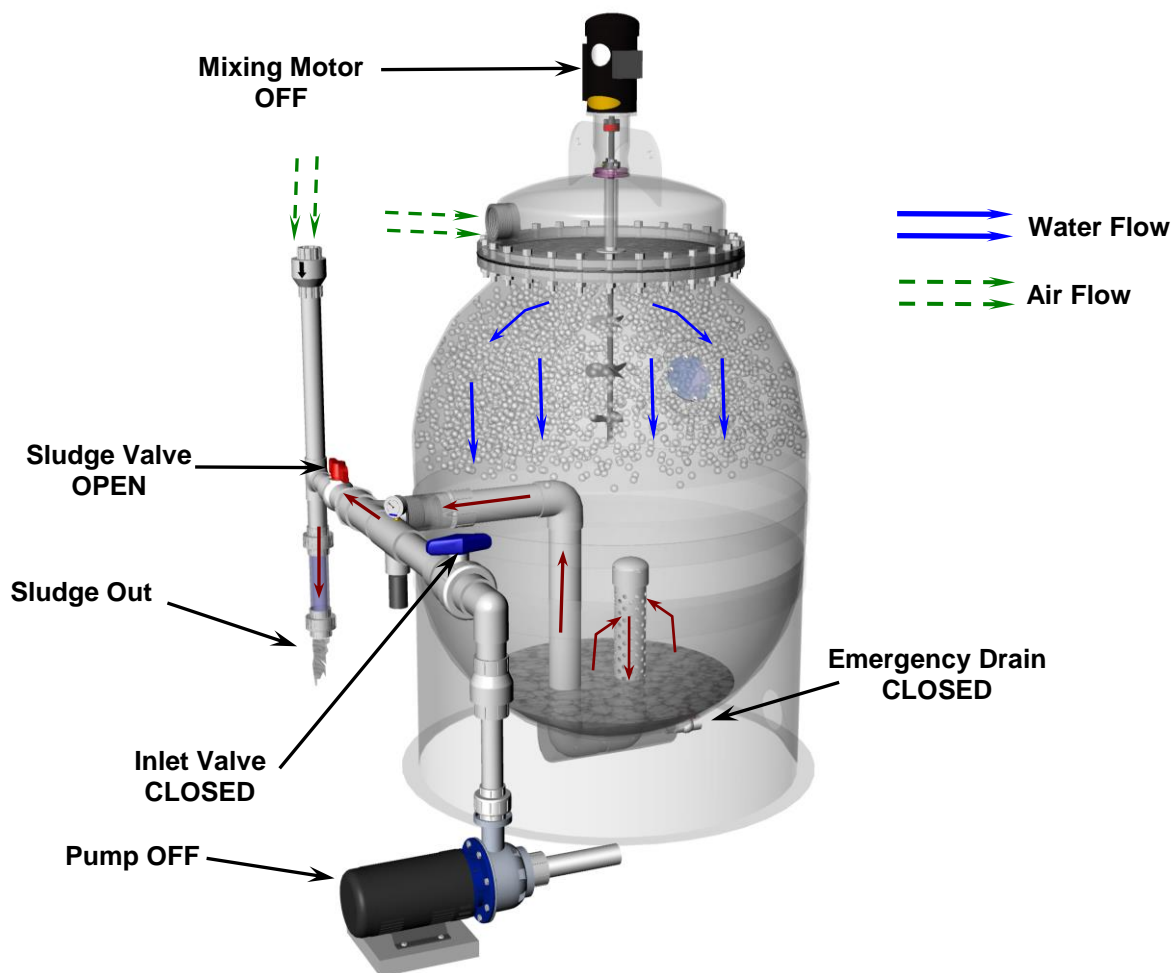

Figure 3.4 Sludge is removed by opening the sludge valve. Water is normally drained until the effluent runs clear. The Emergency Bottom Drain should not be used to drain sludge on a regular basis since it not screened against bead loss.

3.2 Clarification

Although bead filters are considered excellent clarifiers or solids capture devices, within the context of recirculating aquaculture production systems, the performance of these filters is dependent to a large extent on the size distribution of the suspended solids in the wastewater being treated. Utilization of these filters as clarifiers for other applications is best undertaken after a pilot study has been conducted to determine the filter's removal efficiency under various hydraulic and management regimes.

Bead filters perform well in the control of suspended solids across a broad spectrum of conditions. Bead filters capture solids through four identifiable mechanisms (Table 3.2). With the exception of adsorption, the solids capture mechanisms are physical in nature and are common to all types of granular media filters. As a general observation, the filters seem to control fine colloidal particles best with some biofilm development. This suggests that the biofilm absorption process is an important mechanism in the control of fine suspended solids and thus water clarity. Studies have shown that bead filters capture 100% of particles > 50 microns and 48% of particles in the 5-10 micron range per pass (Figure 3.5).

Table 3.2 Mechanisms Contributing to the Capture of Solids in a Bead Filter

Mechanisms	Comment
Straining	Direct capture of larger particles as they pass into small openings between the beads.
Settling	Sinking of suspended solids onto the surface of the beads.
Interception	Impact of particles directly onto the surface of a bed.
Adsorption	Small particles are captured and absorbed into the sticky biofilm.

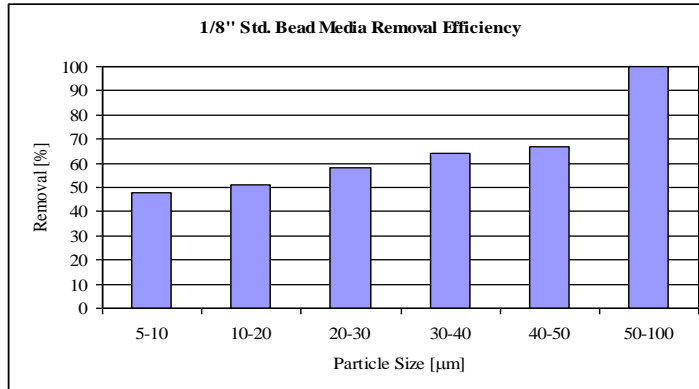

Figure 3.5 Particle Size Removal Efficiency. All particles above 50 microns are removed in the first pass through the filter and the remainder is removed with multiple passes.

The flowrate delivered to a bead filter is the principle management factor influencing suspended solids removal. The efficiency (single pass percent reduction in TSS) of a bead filter generally increases as the flowrate to the filter decreases; however, the capture rate (mass of TSS captured) tends to increase with flowrate. This apparent contradiction occurs because per pass efficiency is relatively insensitive to changes in flowrate, and so, minor drops in efficiency that occur with flow increases are more than compensated for by enhanced solids transport to the filter. In single pass applications, the flowrate should be adjusted downward from the maximum design flow if enhanced removal efficiency is desired. Generally, recirculating rates used with closed or partially recycled systems should be maximized to obtain the lowest possible TSS level in the holding tanks.

Backflushing operations also have an impact on clarification. Generally, bead filters operated strictly for clarification of recirculated waters should be backflushed frequently to minimize pressure loss and sludge retention time in the system. Frequent backflushing tends to reduce the oxygen demand of the filters, but, can also reduce beneficial bacterial action (nitrification). The PBF series filters are highly resistance to biofouling problems and, thus, can be regulated strictly on a hydraulic basis when used for clarification only. High-pressure losses (> 10 psi) across the bed should be avoided since they will result in increased energy costs or flow reductions. However, the benefits of frequent flushing are limited, as clarification performance remains good to excellent for most applications throughout a filtration cycle. As long as pressure build-ups do not become a factor, only small benefits will be realized by increasing backflushing frequency.

There are a few clarification applications for which the PBF series filters are generally not recommended. The most notable is the treatment of wastewaters containing a high concentration of particulate fats or other floatable material. Separation of captured solids from the bead bed is accomplished by sedimentation of released sludge after the bed is agitated. Materials such as fats or wood chips merely float upward with the beads and are not removed. In sufficient quantity, these materials will eventually foul the bed requiring media replacement. Bead filters are also not well suited for the clarification of waters suffering from mineral turbidity problems caused by fine clays or other colloidal particles. Lacking good biofilm development, the mechanisms for the capture efficiencies are unacceptably low. Finally, the bead filters will impact but cannot control planktonic algal blooms. Although some capture occurs as a general rule, the algae can grow faster than they can be caught and thus little progress towards clarification is made. Application of the bead filter technology to the problem of colloidal mineral turbidity or algal blooms requires the use of supplemental treatments (chemical flocculation or U.V. disinfection, respectively) or the filter will be ineffective.

3.3 Biofiltration

In the biofiltration mode, bead filters are classified as fixed film reactors. Each bead (Figure 3.6) becomes coated with a thin film of bacteria that extracts nourishment from the wastewater as it passes through the bed. There are two general classifications of bacteria, heterotrophic and nitrifying, that are of particular interest (Table 3.3). The two bacteria co-exist in the filter, and understanding their impact on each other as well as on the filter is critical.

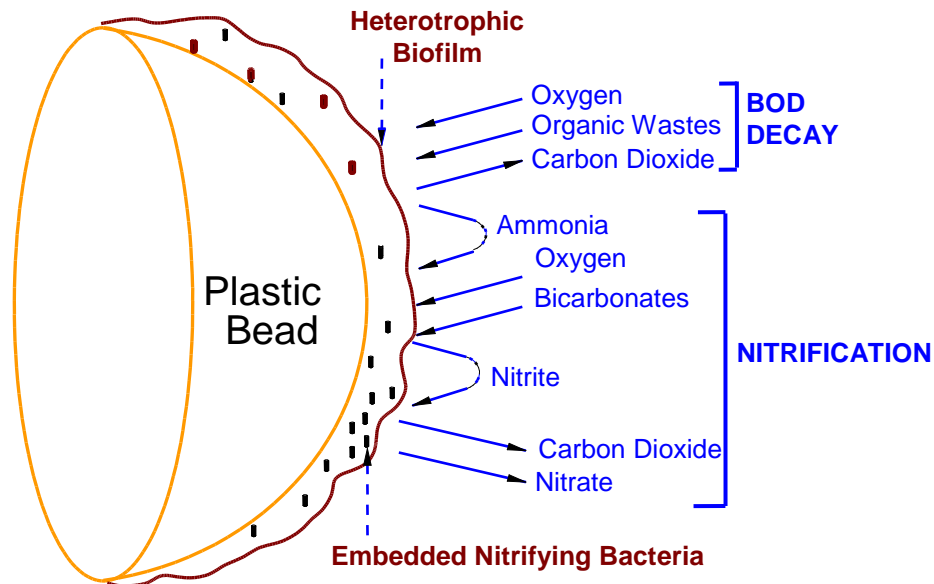

Figure 3.6 The bacterial film that coats each bead contains the nitrifying bacterial population. Heterotrophic bacteria also form a thin biofilm layer on each bead. The nitrifying bacteria compete with the heterotrophic bacteria for space.

Table 3.3 In the Biofiltration Mode, Bead Filters Cultivate Two Types of Bacteria which Perform the Critical Biofiltration Function.

	Heterotrophic Bacteria	Nitrifying
Function	Remove dissolved organics (BOD) from the water column; breakdown and decay organic sludges.	Convert toxic ammonia and nitrite to nitrate.
Reproduction Rate	Very fast (10 – 15 minutes)	Slow (12 – 36 hours)
Yield (mg bacteria/mg waste consumed)	0.6 – 0.8	0.05 – 0.10
Bead adhesion	Poor	Good

The classification of heterotrophic bacteria encompasses a great number of genera/species that share the common characteristics of extracting their nourishment from the breakdown (decay) of organic matter. Biochemical oxygen demand (BOD) is largely an indirect measure of the biodegradable organic material in water. Heterotrophic bacteria reduce BOD levels, consuming oxygen in the process. About 60 percent of the organic matter consumed is converted to bacterial biomass; whereas, the balance (40 percent) is converted to carbon dioxide, water, or ammonia. Heterotrophic bacteria grow very fast and are capable of doubling their population every ten to fifteen minutes. If the BOD in the water being treated is very high (> 20 mg -O₂/l), the heterotrophs will quickly dominate the bead bed, overgrowing the slower growing nitrifying bacteria and consuming tremendous amounts of oxygen.

The second, yet more important, classification of bacteria is the nitrifying bacteria. These bacteria are specialists, extracting energy for growth from the chemical conversion of ammonia to nitrite and from nitrite to nitrate (Figure 3.7). Nitrate is a stable end product, which, although a valuable nutrient for plants, displays little of the toxic impacts of ammonia and nitrite. Composed principally of two genera (Nitrosomonas and Nitrobacter), nitrifying bacteria are very slow growing and sensitive to a wide variety of water quality factors. It is not surprising that most bead filters used for biofiltration are managed to optimize conditions for nitrification. Additionally, it should be noted that nitrifying bacteria utilize inorganic carbon as energy source.

3.3.1 Acclimation

Development of a biofilm layer on the media is required for biofiltration. The bacterial culture, which grows attached to the beads, performs the biochemical transformations that are so critical in the purification of recycled waters. Initially the biofilter has no bacteria and the culture must be started. The process of growing the initial bacterial culture in the biofilter or adjusting an established culture to a change in loading is called acclimation. Fortunately, the process of biofilter acclimation is easy. It just takes a little time and food for the bacteria.

The best way to acclimate a recirculating system with a biofilter is to just add a few hardy fish, turtles, or mollusks to the system and start to feed them. The total suspended solids in the system will pose no problem because bead filters capture solids primarily by physical processes that are not dependent on the development of a biofilm. The heterotrophic bacteria will grow rapidly and quickly attach themselves to the beads, so BOD accumulation should pose no problem. The nitrifying bacteria, however, are very slow reproducers and may require upto 30 days in freshwater under warm water conditions (2 - 3 weeks is more typical) to establish themselves and upto 60-90 days in saltwater under warm water conditions.

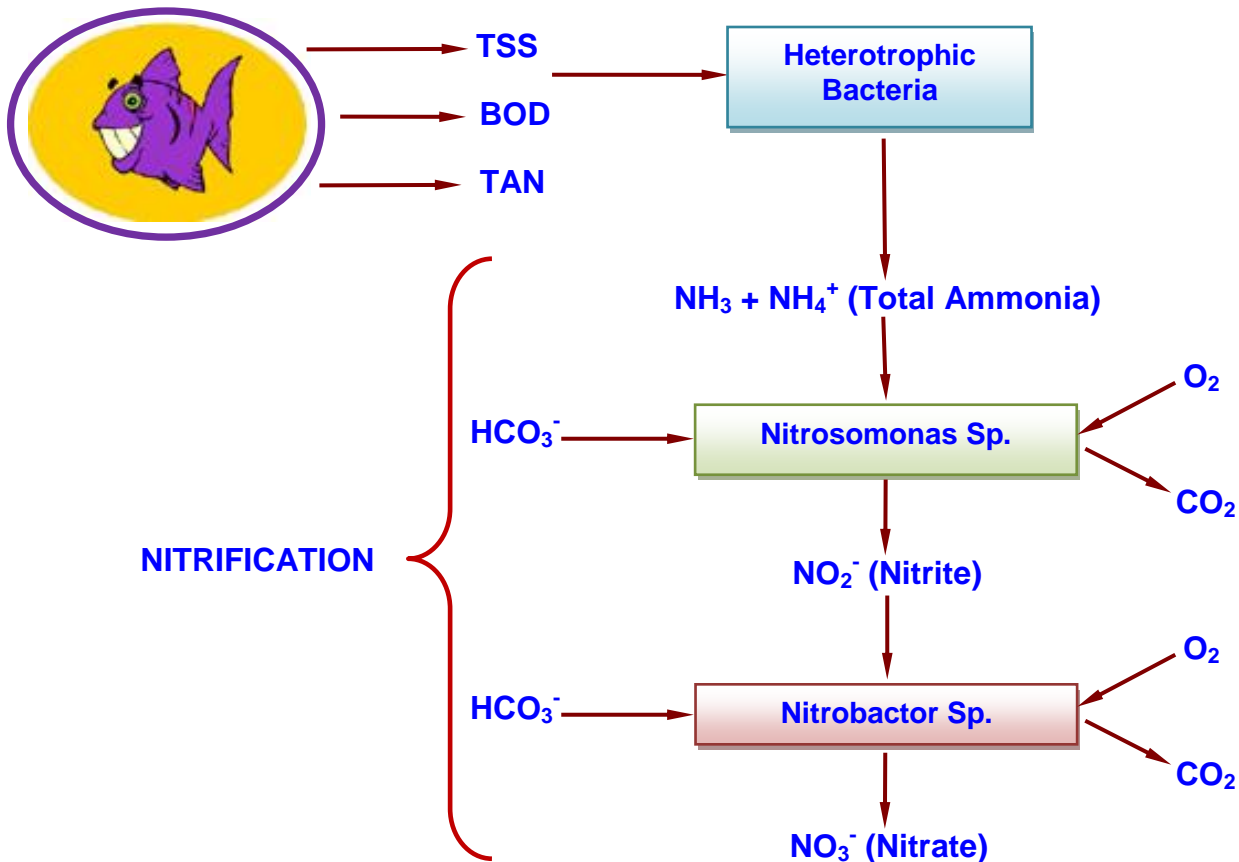

Figure 3.7 Two specialized types of nitrifying bacteria convert toxic Ammonia and Nitrite to the relatively safe Nitrate. Bicarbonate ions and oxygen are required in large amounts.

Figure 3.8 illustrates the classical pattern of TAN and nitrite concentrations observed during filter acclimation with animals. The process starts with an increase in TAN concentrations. You will know that the first group of nitrifiers responsible for ammonia conversion to nitrite are present in large numbers when the ammonia excreted by the fish stops accumulating and suddenly (within 36 hours) drops to near zero levels. At the same time there will be a sudden rise in nitrite levels, followed by a gradual increase which will continue until suddenly the second group of bacteria, Nitrobacter, catch up with their new food supply and the nitrite concentrations plummet. The filter is now considered acclimated to a light loading. This initial stage of acclimation is critical because during this period populations of bacteria which can effectively attack the specific waste produced by the animals become established and these bacterial populations adjust to operate under the water quality conditions and temperature regime found in your system. This unique culture of bacteria will remain in the biofilter for years if it is just treated with a little common sense.

Table 3.4 summarizes things you can do to accelerate the initial acclimation of the bead filter. These procedures can reduce acclimation time to as little as two weeks in a warmwater system. One of the principal limitations of acclimating a filter with animals is that little or no nitrite is available for the growth of Nitrobacter until the Nitrosomonas population has become established. This means that the very slow growing Nitrobacter cannot even get started for over a week. So you can simply cut a week off the acclimation time by adding nitrite at the start. The acclimation process becomes moot if you have an acclimated bead filter on your premises. Just exchange a few cubic feet of acclimated beads from the old filter with new beads and both filters will adjust rapidly. Lacking the beads, have a friend provide you with backwash waters from an established filter. Just dump the sludge into the system. The bead filter will

pick it up and leave the solids in intimate contact with the beads where the transfer of desirable bacteria will rapidly take place. Finally, do not backwash the bead filter during acclimation. Only weekly backwashing should be performed as allowed by pressure buildup during acclimation. Frequent backwashing will just encourage the loss of beneficial bacteria before they are firmly established in the filter, while weekly backwashing will hold de-stratifying bed.

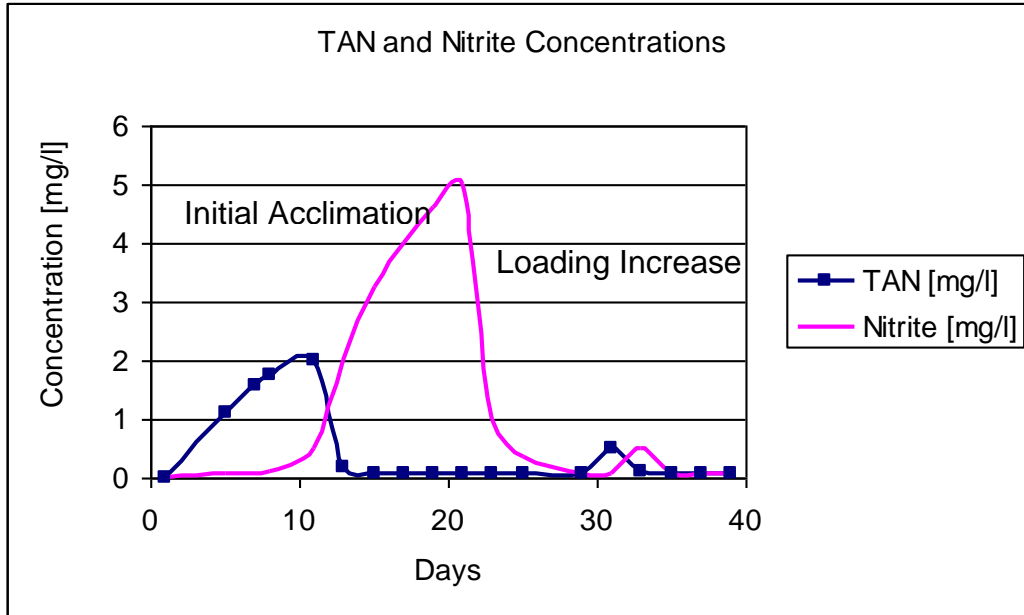

Figure 3.8 TAN and Nitrite concentration build-ups are normally observed during the initial acclimation of a biofilter.

Table 3.4 Things You can do to Accelerate the Initial Acclimation of a Bead Filter

	Procedure	How does it help?
1	Add sodium nitrite at a concentration of 1 mg-N/l on the first day.	Allows growth of <u>Nitrobacter</u> to start immediately.
2	Add backwash waters or beads from an established biofilter.*	Introduces species/strains of bacteria that are well suited for the bead filter's ecosystem.
3	Do not backwash bead filter. **	Minimizes the loss of biofloc.
4	Raise the temperature of the system to 30° C.	Accelerates bacterial growth rates by increasing metabolic rates.
5	Adjust the ph to 8.0.	Accelerates bacterial growth rates by increasing ammonia (NH ₃) concentrations.
6	Add sodium bicarbonate to raise the alkalinity to 150 mg-CaCO ₃ /l	Accelerates bacterial growth rates by increasing biocarbonate availability.
* Disease may be spread with the biofilm, so make sure the source is healthy.		
** Backwash only if hull pressures dictate		

You should be careful not to kill the animals which are used to acclimate the filter. The animals you select to use do not need to be the same as you will be culturing. The best choice for freshwater systems is turtles. The ammonia and nitrite concentrations that will be reached will not affect these animals. So you do not have to worry. Tilapia or carp are good choices if fish are used. These animals can tolerate **short-term** exposure to TAN and nitrite levels of about 5-10 mg-N/l without harm if you keep the pH between 7.5 and 8.0 and add some sodium chloride (rock salt) or calcium chloride. Chlorides help prevent nitrite toxicity by blocking nitrite transfer in the gills. The pH range keeps the TAN in the less toxic NH_4^+ form. It is usually the nitrite peak, which is twice to three times as high as the TAN peak, which damages the fish. If the fish show signs of stress (inactivity, lack of hunger, or gaping near the surface), remove them; you will have plenty of food for the bacteria in the water column already. The fish should be reintroduced into the system once both the TAN and nitrite levels fall below 1 mg-N/l.

The initial acclimation assures that the biofilter contains the right type of bacteria. However, you then must adjust the amount of bacteria to assure there are enough of them to process the ammonia produced by the animals in the system. So the next step in the acclimation process is to increase the density of animals in moderate steps allowing some time for the bacterial population to grow to meet the increased demand. This process of acclimation to increased loading is normally undertaken with the animals of choice for culturing, since the TAN and nitrite peaks are small and quickly disappear. As a general statement, an acclimated filter will completely adjust to a sudden increase in fish density (or feed level) within 72 hours. If the step increase is moderate (< 33 percent of current load), the acclimation will probably occur without noticeable peaks. The heights of the acclimation peaks are actually controlled by the density of fish in the system, not by the size of the biofilter. That is, the nitrite peak in a system with a fish density of 0.25 pounds/gallon will display a peak concentration one-half as high as a system with a density of 0.5 pounds/gallon. Table 3.5 summarizes additional methods that can be used to decrease transitional peaks. The process of acclimation to increased loading occurs naturally if the bacteria and animals are allowed to grow together. The bacteria always grow faster, maintaining the proper balance between the biofilm and the animal density. For example, within a growout system, for example, once the filter is acclimated to the fingerling density, the biofilter's ecosystem will take over and maintain the proper balance. Your management responsibility occurs when the natural growth processes are disrupted by sudden (unnatural) changes in the system.

Table 3.5 Things that Can be Done to Decrease Transitional Peaks of TAN and Nitrite When the Animal Density or Feed Rates are Increased

	Procedure	How does it help?
1	Increase your waterloss from the system until the biofilters adjusts.	TAN and nitrite will be flushed with the water.
2	Discontinue or reduce feedrate during the transition.	TAN excretion rates from most animals increases with feeding.
3	Make loading increases in small increments (< 33 percent of current load) and separate steps by about 3 days.	Existing bacteria will absorb most of the increased load and reproduce rapidly.
4	Extend backwashing interval.	Decreases biofloc loss during the critical transition.
5	Adjust pH (7-8) and alkalinity (150-200 mg/L) to optimum range.	Accelerates reproduction of nitrifying bacteria.
6	Artificially increase the TAN loading prior to the increase by dosing of ammonia chloride (NH_4Cl) and sodium nitrate (NaNO_2) to a level of 1 mg-N/l. See calculations below.	Promotes growth of the critical nitrifying bacteria, enriching their density in the biofilm.

Mention problems/issues with acclimation in saltwater.

3.3.2 Determining the Mass of Ammonium Chloride (NH₄Cl) required to get a 1-ppm (or 1 mg/L) Total Ammonia Nitrogen concentration (TAN or NH₄⁺-N) in 100 gals of water

Molecular Weights:

N = 14 gm/mol, H = 1 gm/mol, NH₄⁺ = 18 gm/mol, NH₄Cl = 53.5 gm/mol

Target Concentration: T = 1 mg TAN/L solution = 1.29 × (1 mg NH₄⁺/L solution)
= 1.29 × (0.001 gm NH₄⁺/L solution)

Calculations based on a single liter of solution:

M = Mass of NH₄Cl in 1 liter of solution

$$M = 1.29 \times \left(0.001 \text{ gm } NH_4^+ \frac{1 \text{ mol } NH_4^+}{18 \text{ gm } NH_4^+} \frac{1 \text{ mol } NH_4Cl}{1 \text{ mol } NH_4^+} \frac{53.5 \text{ gm } NH_4Cl}{1 \text{ mol } NH_4Cl} \right) = 0.0038339 \text{ gm } NH_4Cl \quad (3.1)$$

Calculations for entire tank

M_T = Total mass of NH₄Cl required to reach 1 mg/L NH₄⁺-N or TAN

V = Volume of tank = 378.5412 L = 100 gals

M_T = MV = 3.8339 mg NH₄Cl / L solution × V liters
= 3.8339 × 378.5412
= 1451.289 mg = 1.451 gm

Add 1.451 gm Ammonium Chloride (NH₄Cl) to 100 gals of water to get 1 mg/L Total Ammonia Nitrogen (TAN or NH₄⁺-N)

3.3.3 Determining the Mass of Sodium Nitrite (NaNO₂) required to get a 1-ppm (or 1 mg/L) Nitrite Nitrogen concentration (NO₂⁻-N) in 100 gals of water

Molecular Weights:

N = 14 gm/mol, Na = 23 gm/mol, O = 16 gm/mol, NO₂⁻ = 46 gm/mol, NaNO₂ = 69 gm/mol

Target Concentration: T = 1 mg NO₂⁻-N /L solution = 3.29 × (1 mg NO₂⁻/L solution)
= 3.29 × (0.001 gm NO₂⁻/L solution)

Calculations based on a single liter of solution:

M = Mass of NaNO₂ in 1 liter of solution

$$M = 3.29 \times \left(0.001 \text{ gm } NO_2^- \frac{1 \text{ mol } NO_2^-}{46 \text{ gm } NO_2^-} \frac{1 \text{ mol } NaNO_2}{1 \text{ mol } NO_2^-} \frac{69 \text{ gm } NaNO_2}{1 \text{ mol } NaNO_2} \right) = 0.004935 \text{ gm } NaNO_2 \quad (3.2)$$

Calculations for entire tank

M_T = Total mass of NaNO₂ required to reach 1 mg/L NO₂⁻-N

V = Volume of tank = 378.5412 L = 100 gals

M_T = MV = 4.935 mg NaNO₂ / L solution × V liters
= 4.935 × 378.5412
= 1868.100 mg = 1.868 gm

Add 1.868 gm Sodium Nitrite (NaNO₂) to 100 gals of water to get 1 mg/L Nitrite Nitrogen (NO₂⁻-N)

4.0 Optimizing Nitrification

Substantial improvements in the nitrification performance and thus the carrying capacity of a bead filter can be realized by implementation of a good management plan. The management strategy proposed here involves periodic "tuning" of the filter's operation based on routine monitoring of the waters entering and leaving the filter. When combined with flowrates and the surface area characteristics, these data can define the filter's effectiveness, allowing comparison to other bead filters and other biofiltration formats. Recognition of the fact that bead filters function as fixed film reactors is fundamental to this approach. This means that performance will be closely linked to the amount of surface area available to support the biofilm. By normalizing the rates of nitrification (and oxygen consumption) over the total surface area, filters of different volumes or beads can be compared. This permits the experiences from a wide variety of applications to be integrated so that the "mystery" of biofiltration can be systematically eliminated. In the following sections, methodologies for collecting data, calculating constants, and fine-tuning the filter's performance are presented.

4.1 Areal Nitrification Rates

The volumetric ammonia conversion rate constant, C_V , is a measure of how effectively a biofilter converts ammonia to nitrite. The units of C_V are grams TAN converted per cubic foot of media volume per day (or g/ft^3 -day). The conversion capabilities of a biofilter are influenced by a wide variety of water quality factors (Table 4.1). The TAN concentration is particularly important. As a general statement, the conversion rate increases with increasing TAN concentrations. Also, the organic loading (or BOD) indirectly impacts nitrification by controlling the growth of heterotrophic biofloc. So a filter's performance must be evaluated within the context of a given loading regime, which is normally defined by the amount of feed consumed relative to the filter's size. Table 4.1 presents baseline C_V values that are readily obtainable with a reasonable filter management plan for a variety of loading conditions.

Table 4.1 Water Quality Factors Impacting Nitrification in the Biofilter (Malone et al., 1993)

Primary Parameter	Desired Range	Importance	References
Total Ammonia Nitrogen (TAN)	<1.0mg/L	Rates of nitrification are directly proportional to TAN concentrations. Exposure of biofilms to high TAN levels enhances filter performance.	Knowles et al., 1965 Chitta, 1993
Nitrite (NO ₂ -N)	<1.0 MG/l	Conversion of nitrite usually does not limit biofilter performance unless low dissolved oxygen exist or the filter has been shock loaded	Manthe et al., 1985
Dissolved Oxygen (DO)	> 3.0 mg/L in the Filter Effluent	High oxygen levels are desirable in biofilters since the nitrifying bacteria only function in the presence of oxygen. Additionally, decay processes that occur in the absence of oxygen produce obnoxious chemicals and odors that contribute to off-flavors.	Sharma and Alhert, 1977 Dowing et al., 1964 Manthe et al., 1985
pH	7.5 – 8.0	Low pH values (below 7.0) inhibit nitrification kinetics	Shieh and LaMotte 1979 Paz, 1984
Alkalinity	>150 mg/L as CaCO ₃	Alkalinity controls the pH level and the bicarbonate ion (the principle alkalinity component) is a preferred carbon source for nitrifying bacteria. Low alkalinity levels inhibit nitrification in the biofilter.	Allain, 1988 Paz, 1984
Temperature	25 - 30° C	Temperature controls the heterotrophic and nitrifying bacterial conversion rates.	Dowing et al., 1964 Sharma and Ahlert, 1977

The actual nitrification performance can be determined by measuring the influent TAN concentration (TAN_I in mg-N/l), the effluent TAN concentration (TAN_E in mg-N/l) and the flowrate through the filter (Q in gallons per minute) and entering them into Equation 4.1:

$$C_A = \frac{5,450 (TAN_I - TAN_E) Q}{(V) (S_A)} \quad (4.1)$$

where V is the volume of beads in the filter (in ft^3), S_A is the specific surface area of the bead (in square feet of surface area per cubic feet of beads, ft^2/ft^3) and 5,450 represents a conversion factor correcting for differences in units of the various terms.

Table 4.2 Values of the Areal Ammonia Conversion Rate, C_A that you should easily obtain for Different Loading Regimes

TAN (mg/l)	Loading * (#/ft ³ -day)	C_A (mg/ft ² -day)	Controlling Factor
0.1	< 0.5	5	TAN availability
0.3	0.5 – 1.0	10	TAN availability
0.5	1.0 – 1.5	20	Optimal performance
1.0	1.5 – 2.0	25	Hydraulic conductivity
>1.0	>2.0	15	Biofloc age

*Approximate feeding rate in pounds of feed fed per cubic feet of beads under the assumption that all the feed is consumed.

The areal nitrite conversion rate, C_N , can be defined in a similar manner by Equation 4.2:

$$C_N = C_A = \frac{5,450 (N_I - N_E) Q}{(V) (S_A)} \quad (4.2)$$

Where N_I is the influent nitrite concentration (mg-N/l) and N_E is the effluent nitrite concentration (mg-N/l). As Equation 4.2 illustrates, the readings of influent and effluent nitrite must be combined with the ammonia conversion rate to determine the level of Nitrobacter activity since nitrite is being produced as the ammonia is converted within the bed.

The third equation which proves very helpful in the management of bead filters measures the amount of bacterial action by calculating the areal oxygen consumption rate, C_{XT} :

$$C_{XT} = \frac{5,450 (O_I - O_E) Q}{(V) (S_A)} \quad (4.3)$$

Where O_I is the influent dissolved oxygen concentration (mg- O_2 /l) and O_E is the dissolved oxygen concentration (mg- O_2 /l) in the water leaving the filter. C_{XT} measures the combined respirational activities of the nitrifying bacteria, the heterotrophic bacteria extracting soluble BOD from the water column, and the heterotrophic bacteria responsible for the breakdown of solids (sludge) held in the filter. The apparent areal oxygen consumption rate C_{XN} (mg- O_2 /ft²-day) of the nitrifying bacteria can be computed directly from the areal conversion rates for nitrification since we know the amount of oxygen required for nitrification from chemical equations:

$$C_{XN} = 3.43 C_A + 1.14 C_N \quad (4.4)$$

The areal oxygen consumption rate, C_{XH} (mg- O_2 /ft²-day) which can be attributed to heterotrophic activity can then be calculated by difference:

$$C_{XH} = C_{XT} - C_{XN} \quad (4.5)$$

Finally, the percentage of respirational activities that can be attributed to nitrification, F_{XN} , can be defined:

$$F_{XN} = C_{XN}/C_{XT} \times 100 \quad (4.6)$$

Generally, optimum filter performances (high C_A and C_N) are associated with moderate to low values of C_{XT} and thus high values for F_{XN} . The magnitude of C_{XT} increases with increases in organic loading (feed rate) and declines with increasing backflushing regime.

4.2 Sample Calculations

The best way to collect influent and effluent samples is through sampling ports placed immediately adjacent to the filter housing (Figure 4.1). This placement minimizes the impact on bacteria attached to the walls of the pipes and allows the sampled waters to be easily inspected for bubbles. The presence of bubbles will cause errors in the dissolved oxygen measurements. Bubbles in the influent line are generally caused by leaky fittings on the suction side of the pump which must be fixed or they will cause problems both with your dissolved oxygen measurements and your filter's performance. Bubbles in the effluent sample indicate that the discharge line is not flowing full or siphoning action is causing air to be drawn in through the shaft seals. Both of these effluent pipe problems can be avoided by placing a valve on the discharge line downstream of the effluent sampling port. This valve is then closed just enough to cause the discharge pipe to run full, but not enough to cause a significant backpressure. This valve setting should only be adjusted once for each flowrate. Adjusting the valve at the time of sampling will cause a bed disruption that may lead to misleading results. The best procedure for collecting samples is to place the tubing running from the sampling port down into the sample bottle and allow the flowing water to flush the bottle several times.

Table 4.3 presents an illustration of how routine monitoring data can be converted into the filter performance constants developed in Equations 4.1 through 4.6.

Table 4.3 Sample Calculations of Performance Constants for a 6 Cubic Foot Bead Filter with a specific Surface Area of 400 ft²/ft³.

Parameter	Value	Units	Comment
Q	36	gpm	
TAN _I	0.78	mg-N/l	
TAN _E	0.61	mg-N/l	
N _I	0.34	mg-N/l	
N _E	0.31	mg-N/l	
O _I	5.8	mg-O ₂ /l	
O _E	93.4	mg-O ₂ /l	
C _A	15.9	mg-N/ft ² -day	Equation 4.1
C _N	18.7	mg-N/ft ² -day	Equation 4.2
C _{XT}	224	mg-O ₂ /ft ² -day	Equation 4.3
C _{XN}	75	mg-O ₂ /ft ² -day	Equation 4.4
C _{XH}	149	mg-O ₂ /ft ² -day	Equation 4.5
F _{XN}	34	percent	Equation 4.6

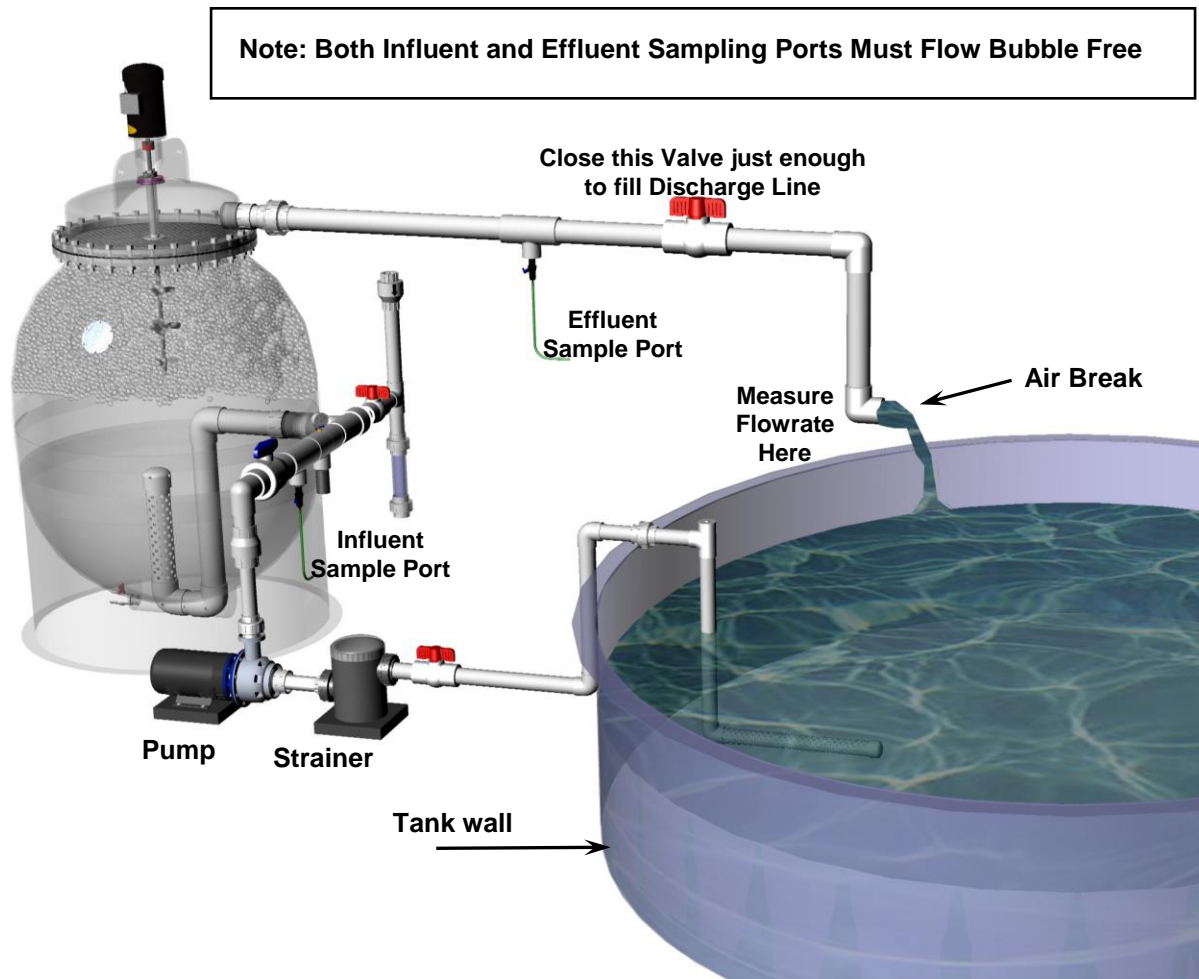

Figure 4.1 Sampling ports should be added to the influent and effluent pipes to facilitate data collection.

4.3 Discussion

A plan designed to optimize the performance of a biofilter must simultaneously provide for management of water quality, biofilm, and nutrient transport. This is not particularly difficult as long as the relationships between the design or operational parameters and performance are understood (Figure 4.2). The following paragraphs provide some background on how the operational parameters impact the nitrification rates (C_A or C_N). Additionally a methodology for systematically improving the filter's nitrification capacity is presented.

Bacteria implement enzymatic reactions to obtain energy or nutrients, and to build the molecular components of their cells. The Nitrosomonas species of bacteria include the enzyme set necessary to extract energy from the conversion of ammonia to nitrite, while Nitrobacter has the enzymes required to benefit from the conversion of nitrite to nitrate. In fact, you may think of a bacterial cell as a package of enzymes. The type of bacteria determines the kind of enzymes.

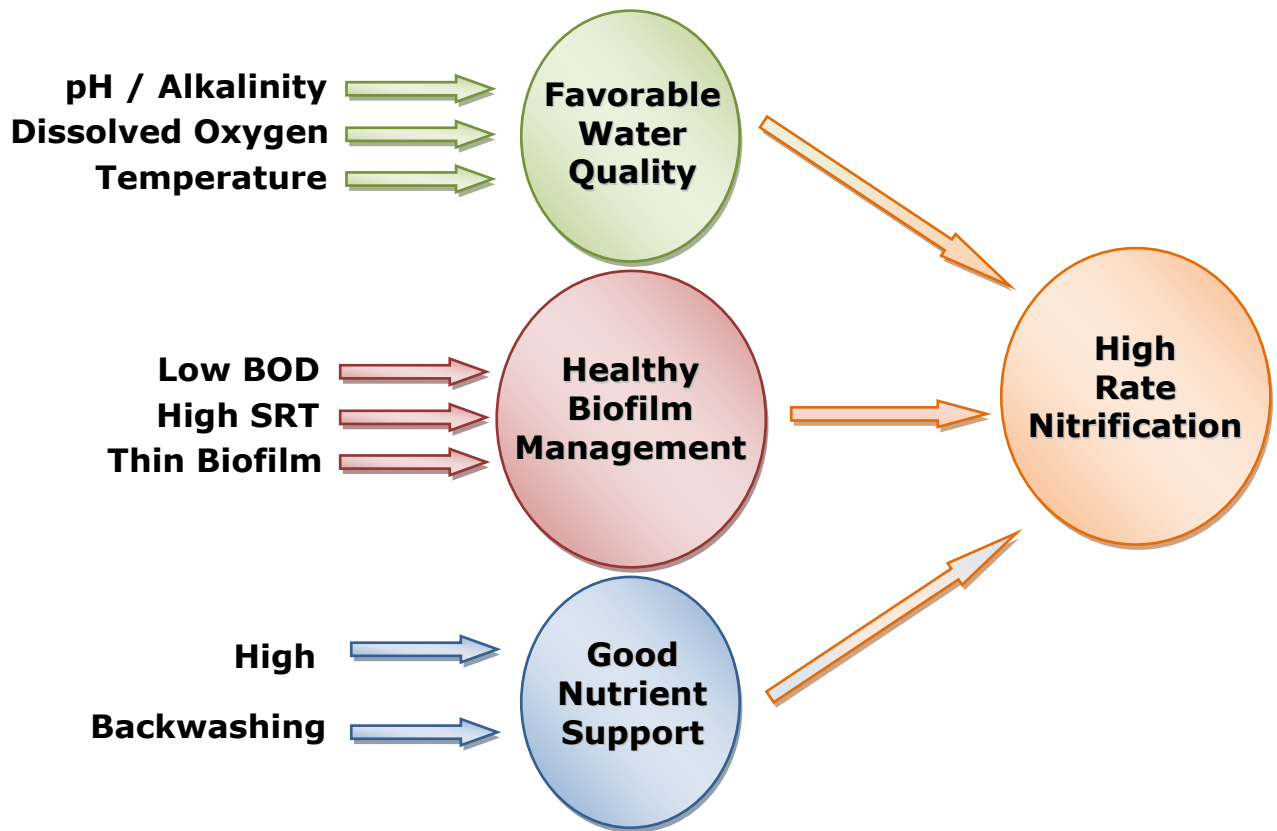

Figure 4.2 Biofilm management, good nutrient transport and favorable water quality enhance the nitrification.

4.3.1 Water Quality

The speed of enzymatic reactions is controlled first by temperature, which defines the magnitude of chemical activity. Additionally, the reaction rate is controlled by the amount of the critical enzyme and by the level (or concentration) of the reactants that must be brought together to produce the products. The nitrification reactions require a substrate (ammonia or nitrite), a set of enzymes (found in Nitrosomonas or Nitrobacter), an electron acceptor (oxygen) and a carbon source (bicarbonate ions, HCO_3^-). The objective of operating a biofilter is to keep the TAN and nitrite concentration as low as possible. This is done by keeping the other reactant levels high so that the substrate is utilized very quickly once it enters the biofilter.

The most important water quality parameter is oxygen. The speed of the nitrification reaction is not substantially influenced by oxygen as long as the oxygen level is above 4.0 mg/l. Below this level first Nitrobacter, then Nitrosomonas will slow down as the bacteria are forced to wait for oxygen to reach them. When the dissolved oxygen level coming out of the filter (O_E) is above 4.0 mg/l, it is generally safe to assume that most of the bed has enough oxygen to keep the enzymes working at top speed. By the time effluent oxygen levels drop to about 2.0 mg/l large portions of the bead are impaired by lack of oxygen. High rate nitrification requires that the entire bed be kept working at maximum speed. Effluent dissolved oxygen levels must be kept above 4.0 mg/l.

The supply of bicarbonate ions is controlled by the level of carbonate alkalinity and the pH of the recirculating waters. Carbonate alkalinity is defined by the concentration of the carbonate ion ($\text{CO}_3^{=}$) and bicarbonate ion (HCO_3^-). For all practical purposes only bicarbonate ions exist in significant levels and define total alkalinity levels in recirculating system. Bicarbonate ions are generally replaced by the addition of sodium bicarbonate (baking soda or NaHCO_3). These additions not only increase the bicarbonate supply but also help raise the pH, which also benefits the nitrification process.

Optimum nitrification is usually associated with pH levels above 7.5 and total alkalinity levels above 100 mg-CaCO₃/l. If the pH is still depressed (below 7.5) after the alkalinity has been adjusted then the system has high carbon dioxide levels. Carbon dioxide can be removed by installation of a degasification device.

4.3.2 Biofilm Management

Assuming a favorable water quality regime has been established, the rate of nitrification will then be largely controlled by the mass of bacteria (enzymes) found in the filter. The objective of a biofilm management program is to maximize the relative level of nitrifying bacteria found within a biofilm that is dominated by heterotrophic bacteria. Heterotrophic bacteria utilize organic material derived from the fish wastes as a substrate. They tend to grow rapidly and can quickly over grow and suffocate a colony of nitrifying bacteria. The best way to control them is to starve them by reducing the organic (or BOD) loading to the filter. Bead filters with a light organic loading (pounds of feed per cubic feet of beads) and high TAN concentrations can display extremely high nitrification rates ($C_A > 100$ mg/ft²-day). However, as the organic loading increases, the nitrification efficiency drops off as the heterotrophic bacteria compete for space and nutrients.

The issue of heterotrophic bacterial competition is complexed by the fact that the nitrifying bacteria reproduce very slowly (particularly Nitrobacter). As organic loadings increase, the mass of heterotrophic bacteria increases, clogging the filter and forcing a washing sequence. The washing sequence removes the bulk of the heterotrophic bacteria, the captured TSS that form a major portion of their food source, and unfortunately, a lot of nitrifying bacteria. If the interval between backwashings is too short, the nitrifying bacteria will not have time to re-establish their population and a gradual wash-out occurs, dramatically limiting the nitrification capacity of the filter. So we are faced with a paradox of needing to wash the filter to rid ourselves of the heterotrophic bacteria and captured solids while wishing to slow the backwash

frequency down to assure an average biofilm age high enough for the nitrifying bacteria to reproduce. There is a wide window of backwash intervals that will produce optimal nitrification at low organic loadings (< 1 pound of feed per cubic foot of beads per day). That window closes down as the organic loading approaches 2 pounds of feed per cubic foot of beads per day. Additionally, the optimum backwashing intervals changes as the feed rate increases. We know that the optimum backwash frequency for a loading rate of 1.5 pounds of feed per cubic foot of beads per day is somewhere between once a day and once every three days for warm water systems. But, secondary factors (mixing duration, organic loading, and water quality) make the optimum difficult to predict.

4.3.3 Nutrient Transport

The final issue in optimizing a biofilter's operation is nutrient transport. You must assure that the bacteria within the biofilm are always presented with sufficient levels of TAN (or nitrite), oxygen, and bicarbonate ions to keep the nitrification process proceeding at a high rate. Maintaining good water quality in the rearing tank does not assure that the bacteria, which are residing in the depth of a packed bed of beads, are seeing these same conditions. Good nutrient transport requires first rapid mixing between the rearing tank and the biofilter, and secondly, even flow distribution within the bead bed. Biofilms actively consume (or convert) essential nutrients rapidly depleting supplies in the waters immediately adjacent to them. Water must flow quickly and evenly through a bed of beads to assure that the depleted waters are uniformly and rapidly displaced. Should a section of the bed become clogged by excessive solids or biofloc, then localized pockets will not be flushed and the nitrifying bacteria in that section of the bed will be effectively inactivated, lowering the performance of the bed as a whole.

The flowrates required to assure good mixing between the rearing tank and the filter are readily determined by conducting a mass balance analysis on TAN and oxygen. If this mathematical procedure is followed, a minimal flowrate required to keep below a peak TAN level in the rearing tank can be calculated. These flowrates (typically 2 - 5 gpm per pound of feed per day) are high enough to satisfy the mixing criteria. Additionally, the removal efficiency E (in percent) of the bed can be checked by Equation 4.7:

$$E = \frac{TAN_i - TAN_e}{TAN_i} * 100 \quad (4.7)$$

If the efficiency of a bed exceeds 25 percent, additional nitrification capacity can be realized by increasing flowrate rates and thus raising the mean TAN level within the bed. The second transport issue involves achieving even distribution of nutrients throughout the packed bed of beads. A clean bed will provide for a reasonable flow distribution pattern within the bed. However, even flow distribution is not assured once the influences of solids capture and biofloc growth are considered. It is safe to assume, for example, that large sections of the bed become hydraulically restricted as solids accumulate near the end of the filtration cycle. These hydraulic restrictions deprive bacterial colonies of a continuous supply of nutrients and they become inactive. The principle tool available for controlling nutrient distribution within a bed is backwashing. Each time the bed is washed it is homogenized. The clumps of beads are broken up, solids are purged from the bed, and biofilm thickness is reduced. Although frequent and vigorous backwashing improve hydraulics of the bed, these objectives must be balanced with the desire to hold as much nitrifying bacterial biomass as possible. With this in mind, optimal filter performance occurs when the filters are operated close to the hydraulic clogging zone then washed with minimal propeller activation time.

4.4 Optimization Procedures

Table 4.4 presents some things that you can do to improve your filters nitrification performance. A routine monitoring program to determine C_A and C_N and a little trial and error will rapidly improve a filter's performance since most nitrification problems are caused by gross negligence of operational guidelines.

A more rigorous, systematic approach to optimization is presented in Table 4.5 and illustrated in Figure 4.3. The focus again should be on monitoring the filter's performance. Overall, the optimization procedure is based on the assumption that optimal performance will occur when the bacterial biomass is increased and held just short of manifestation of nutrient transport problems as evidenced by pressure build-ups or low oxygen levels. Although the approach appears complex, familiarization with the procedures will quickly reveal that it is merely a common sense approach to systematically identify what is limiting the filter's nitrification performance. Such a vigorous approach is probably only warranted when a filter is maintained at or near its maximum loading regime.

Table 4.4 Things You Can Do to Enhance the Nitrification Rate of Your Bead Filter

-
- Institute a routine biofilter-monitoring program.
 - Keep effluent dissolved oxygen levels about 4.0 mg/L.
 - Keep the pH above 7.5.
 - Keep alkalinity levels above 150 mg-CaCO₃/l.
 - Decrease backflushing frequency to increase biofloc age.
 - Decrease mixing duration to minimize biofloc loss.
 - Reduce organic loading.
 - Increase flow rates through the filter.
 - Decrease backpressures on the effluent side of the filter.

Table 4.5 Procedural Approach to Tuning a Propeller-washed Bead Filter for Optimum Nitrification.

No.	Action or Test	Yes	No
1	Set the feedrate to a value less than or equal to 1 lbs. of feed per cubic foot of beads per day	Go to 2	
2	Add sodium bicarbonate until an alkalinity of 150 mg-CaCO ₃ /l is reached	Go to 3	
3	Increase degasification until a pH greater than 7.5 is reached	Go to 4	
4	Set the backwash frequency to the "SOP" (Table 6.2) interval of 24 to 48 hours pressure	Go to 5	
5	Wait at least 3 backwash intervals then monitor filter performance and calculate the C _A and C _N values	Go to 6	
6	Are the nitrification constants better than the last setting	Go to 7	Go to 20
7	Are the water quality conditions in the rearing tank acceptable?	Go to 8	Go to 10
8	Record the feedrate, the backwash frequency, and propeller activation duration for future use	Go to 9	
9	Initiate a routing monitoring program for pH, alkalinity, C _A , C _N and C _{XT}	Stop	
10	Was your hull pressure just before backwashing less than 15 psi?	Go to 11	Go to 12
11	Decrease the frequency of backwashing (increase interval between backwashings)	Go to 5	
12	Are the pressures in the filter discharge line above 2 psi?	Go to 13	Go to 15
13	Your filter performance is being limited by plumbing downstream of your filter. Can you fix the problem?	Go to 19	Go to 14
14	Decrease the flowrate to the filter by 10 percent	Go to 5	
15	Is the influent pressure above 7 psi right after backwashing?	Go to 16	Go to 18
16	Observe the filter during the next backwash, are the beads being actively swirled for at least 10 seconds?	Go to 14	Go to 17
17	Increase the propeller activation duration to assure at least 10 seconds of fluidization once the bed begins mixing rapidly	Go to 5	
18	Increase the frequency of backwashing (decrease interval between backwashings)	Go to 5	
19	Change the plumbing configuration to eliminate backpressures downstream of filter	Go to 11	
20	Does the water coming out of your filter contain less than 4 mg-O ₂ /l?	Go to 24	Go to 26
21	Are your beads being fluidized for longer than 10 seconds after complete mixing is achieved during the propeller activation step?	Go to 22	Go to 23
22	Decrease your propeller activation interval by 20 percent or to fluidization plus 5 seconds if the latter is greater	Go to 5	
23	Increase the flow to the filter at least 10 percent	Go to 5	
24	Do the waters coming into your filter contain less than 6.0 mg-O ₂ /l?	Go to 25	Go to 23
25	Increase the aeration in your rearing tank or sump until a level of 6.0 mg-O ₂ /l is obtained	Go to 5	
26	Is the efficiency of TAN conversion greater than 25 percent?	Go to 23	Go to 21

5.0 Trouble Shooting

A trouble-shooting guide is presented in Table 5.1 to assist in the correction of problems that have been observed (or anticipated) in propeller-washed bead filters. Should a problem arise that does not appear in the table, the manufacturer should be contacted for assistance.

1. Unexpected loss of beads from a PBF filter may result from:
 - A. When initially starting up a PBF unit, it is common to have a small number of small, undersized beads pass through the bead retention screen and into the culture tank. While we use virgin plastic bead media in all of our filters, we cannot totally eliminate undersized beads.
 - B. The bottom diffuser assembly on most PBF filters is not screened. Failure to install a siphon break as part of the external plumbing assembly can result in beads being siphoned from the filter. If the siphon break is installed properly, the water level in the filter cannot drop below the inlet fitting on the side of the filter, thus preventing the beads from being drained from the filter.
 - C. Over washing the beads or extended operation of the mixing motor can result in bead loss. If the mixer is run for an extended period of time, beads are forced to the bottom of the filter and become captured in the diffuser. If you suspect this is occurring or have reason to run the mixer for an extended period of time, you can eliminate the bead loss by turning on the recirculation pump for 5 seconds to force any trapped beads from the diffuser.
 - D. Failure to install a check valve between your filter and pump may result in beads siphoning back through the pump and into the fish tank/pond when your pump is off, if the pump fails or if power fails. Refer to Section 2.3.1.
2. The mixing motor should never be run unless the filter is full of water. Running the mixing motor even for very short periods of time without water will result in overheating of the bushing in the motor support pipe. If this occurs you must replace the bushing.
3. If sludge drains from the filter rapidly then slows to a trickle it is generally due to lack of an air break on the top of the filter. This typically occurs when the effluent line is submerged in the culture tank and there is not way for air to enter the filter as the sludge is drained from the filter. Installing a check or manual valve in a TEE on the effluent line easily solves this problem.
4. If you experience cloudy water, you may have a small air leak on the suction side of your pump or an air stone may have migrated to the vicinity of your pump intake. Bubbles accumulating under the bead bed eventually channel upwards releasing solids. If you suspect this may be causing a problem in your system you can tighten all threaded fitting on the intake side of your pump, wipe silicon sealant on all pipe joints and/or move the air stone(s) away from the pump intake.
5. Never open the unscreened emergency bottom drain unless your pump is turned off and your filter is full of water. This valve is not intended to be used during normal backwashing of the filter; it is only to be used periodically to determine if sludge is accumulating in the bottom of the filter or to completely drain the water from the filter. If this valve is inadvertently left open, you can and will drain all the beads from your filter.
6. If when you turn on the mixing motor for the first time the beads do not mix, check the direction of motor rotation. The motor should be spinning clockwise.

Table 5.1 Troubleshooting Guide

Problem	Cause	Definitive Check	Solutions
Reduced Flowrate	Pump failure	Low filter Inlet pressure, pump shut-off pressure below manufacturers specification when both inlet valve and bypass valves are closed.	Service or replace pump. Check pump inlet basket for clogging. Check for air leak on suction side of pump.
	Clogged filter	High inlet pressure, sequential backwashing of filter restores flow.	Reduce organic and/or solids loading to filter. Increase backwash frequency. Increase mixing duration. Increase drain time for sludge removal.
	Clogged diffuser assembly (rare)	High inlet pressure, draining water through sludge drain line without mixing bed restores flow.	Install inline strainer ahead of water pump.
	Undersized pump	Low filter Inlet pressure, pump shut-off pressure good.	Install larger pump. Reduce parallel water demands.
	Improper valve settings	Low filter inlet pressure.	Reset valve.
Poor TAN conversion (low C_A)	Excessive backwashing	Beads in viewing port appear very clean; high nitrite concentrations.	Reduce backwash frequency. Reduce mixing duration.
	Low pH	pH below 7.0, alkalinity above 100 mg $CaCO_3/l$, pH rises above 7.5 when sample is aerated for 1 hour.	Increase the degasification capacity of your system, carbon dioxide levels is high.
		pH below 7.0, alkalinity below 100 mg $CaCO_3/l$.	Add sodium bicarbonate and increase degasification.
	Low alkalinity	pH above 7.0, alkalinity below 100 mg $CaCO_3/l$.	Add sodium bicarbonate.
	Low dissolved oxygen	Dissolved oxygen levels below 2.0 mg- O_2/l in filter outlet; high nitrite concentrations; inlet dissolved oxygen below 5.0 mg/l.	Increase aeration of inlet waters. Increase flowrate to filter.
	Antibiotics	Did you just treat your fish?	Discontinue use of antibiotics known to inhibit nitrification; purge system; re-acclimate filter.
	Poor Acclimation	Has the system been recently started or shock loaded?	Review acclimation procedures. Reduce feedrate and increase water flush rate until filter acclimates.
	Excessive organic (BOD) loading	Dissolved oxygen levels below 2.0 mg- O_2/l ; inlet dissolved oxygen above 5.0 mg/l; difficulty initiating mixing.	Reduce feedrates. Reduce fish density.
Cloudy water	Overfeeding	Uneaten food in tank; feed particles in sludge.	Reduce feed rate and/or alter feeding frequency.
	Algae	Water is green or rusty brown; check with microscope.	Add an ultraviolet light disinfection system to recirculation loop or shade the system.
	Sludge accumulation	Sludge stinks; short filtration cycle with high initial headloss; turbid discharge at start of filtration cycle.	Make sure filter sludge discharge runs clear at end of sludge withdrawal; increase backwash frequency; verify good mixing during backwash cycle.
	Clays	Milky brown color; identify source.	Eliminate source of input.
	Air in intake line	Bubbles visible through viewing port; present in discharge line; or in pump strainer.	Reseal fittings on the intake side of pump. Move airstones away from pump intake.

Table 5.1 Troubleshooting Guide (Continued)

Problem	Cause	Definitive Check	Solution
Sludge will not drain	No air break	Loosen mixing head flange (part B.1a, Figure 1.3). Sludge line should drain rapidly.	Add check valve to discharge side of filter so air can enter casing.
	Diffuser clogged (rare)	High operating pressures; remove diffuser assembly and inspect.	Prescreen influent waters to remove causative agents. Clean or replace diffuser.
Mixing head leaks around propeller shaft	Mechanical Seal Failure	Water observed spraying from packing gland.	Replace Mechanical Seals. See Section 7.0.
Beads will not mix during backwash	Excessive biofouling	Motor stalls and fails to start or blows fuse; shaft turns freely when filter is drained.	Remove about 15 percent of water from filter; restart mixing motor; fill, backwash, and remove sludge sequentially until beads are clean; increase backwashing frequency or otherwise correct washing sequence to prevent re-occurrence of problem.
		Motor and propeller shaft turn with no mixing at window.	Let the propeller run for an extended period until beads wash freely; increase backwashing frequency or otherwise correct washing sequence to prevent re-occurrence of problem.
	Loose propeller	Motor and propeller shaft turn with no mixing at window after extended time; remove propeller shaft and inspect.	Call manufacturer, placement of propeller is critical for proper washing.
	Motor wired backwards	Watch rotation of coupling, it should rotate clockwise when view from top.	Rewire mixing motor according to directions.
Finding small beads or fines in culture tank or pond			This is normal. We purchase beads in bulk and there are always going to be some, which are undersized and pass through the screen. This should decrease with time then stop altogether after several months. If this causes a problem, simply put a sock over discharge and capture them.

6.0 Filter Specifications

Figure 6.1 and Table 6.1 and 6.2 present the specifications for all of the current propeller-washed filter models. Table 6.1 contains the specifications of our standard filter models, while Table 6.2 contains those of our “Special” or high flow models. The hydraulic values provided (backwash waterloss, flowrate, and pressure drop) are approximate since they are strongly influenced by the filter management.

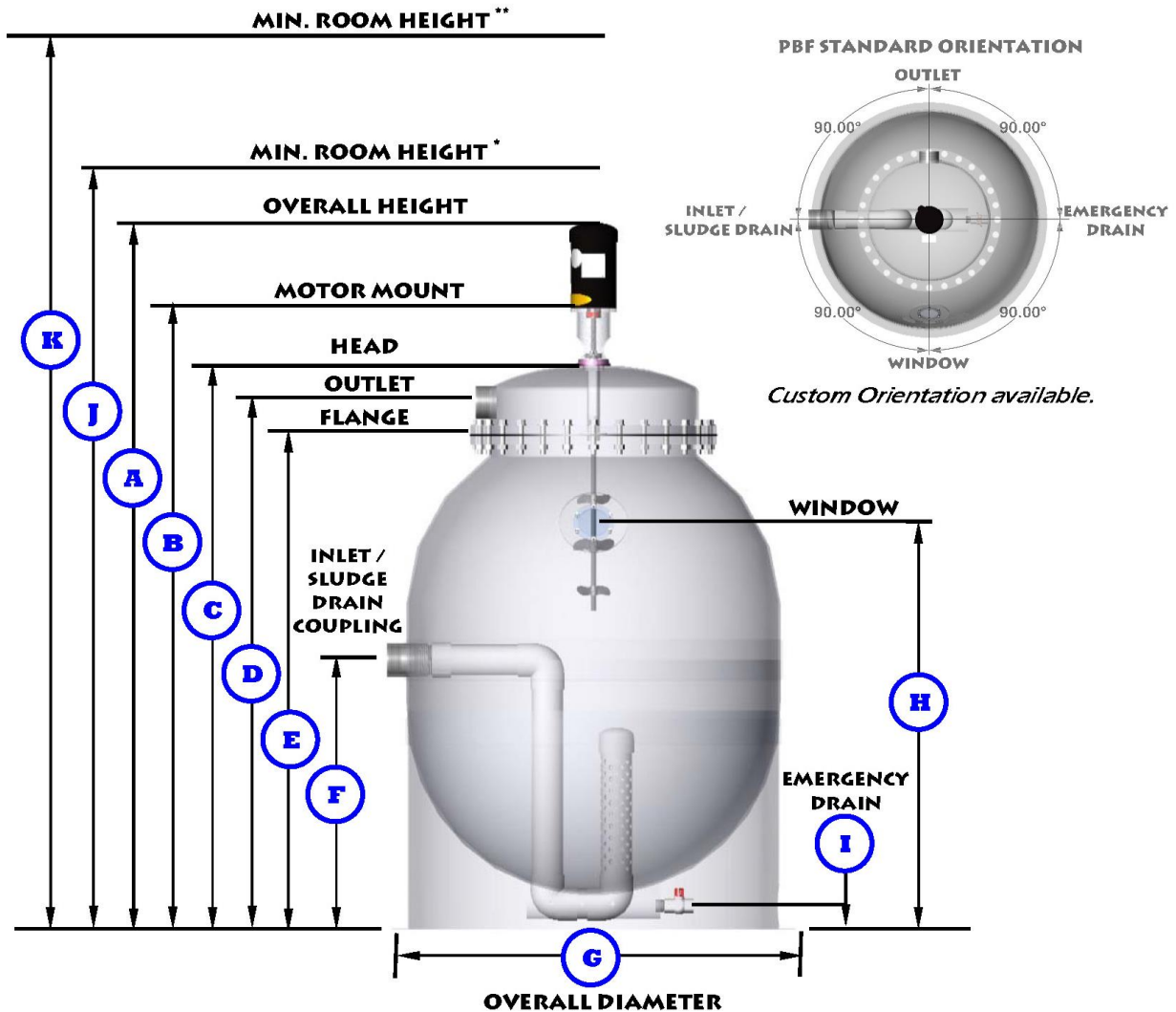

Figure 6.1 Filter Dimensions (see Table 6.1 below for individual filter dimensions)

Table 6.1 Dimensions and Specifications for the standard PBF Model Bead Filters

	Specifications	PBF-3	PBF-5	PBF-10	PBF-25	PBF-50	PBF-100
A	Overall Height w/ motor installed	64.5"	~77"	87"	~104"	117"	~150"
B	Height to Motor Bracket	55"	68"	76"	92"	104"	130"
C	Height to top of filter cap	46.25"	60"	68"	83.5"	95.5"	122"
D	Outlet Pipe Height	43"	56"	64"	81"	91.5"	121"
E	Height to Filter Flange	39.5"	56"	60"	76"	85.5"	112"
F	Inlet/Sludge Outlet Height	~5 - 5.5"	30"	36"	40.5"	52"	58"
G	Overall Diameter	33"	34"	40"	59"	72"	92"
H	Window Height	30"	38.5"	47.5"	54.5"	73"	87"
I	Emergency Drain Height	5.5"	3"	3"	3.5"	4"	~5.5"
J	Min. Room Height Required*	69"	82"	91"	108"	122"	156"
K	Min. Room Height Required**	6 Feet	7.5 Feet	8.5 Feet	10.5 Feet	11.5 Feet	14.5 Feet
	Inlet/Sludge Discharge Pipe Size/Type	1 ½" Fipt	1 ½" Fipt	2" Fipt	3" Fipt	4" Fipt	6" Fipt
	Outlet Pipe Size/Type***	2" Fipt	2" Fipt	3" Fipt	3" Fipt	2- 4" Fipt	2- 6" Fipt
	Bead Capacity (ft ³)	3	5	10	25	50	100
	Specific Surface Area (ft ² /ft ³)	400	400	400	400	400	400
	Total Surface Area Available For Nitrification (ft ²)	1,200	2,000	4,000	10,000	20,000	40,000
	Maximum Allowable Hull Pressure (psi)	10	20	20	20	20	20
	Typical Pressure Drop Across Clean Filter Bed (psi)	1-2	2-3	2-5	3-5	3-6	4-7
	Maximum Flowrate (gpm)	30	50	100	200	300	600
	Typical Pump Horsepower	1/6 - ½	1/4 - ½	3/4 - 1 ½	1 ½ - 2	2 - 5 (2 pumps)	5 - 10 (2 pumps)
	Estimated Backwash Waterloss (gallons)/backwash	6-10	6-10	10-30	30-60	50-150	100-200
	Mixing Motor****	1/3 Hp 115/208-230 V 1 phase 5.6/2.7-2.8 amps 60Hz	½ Hp 115/208-230 V 1 phase 7.4/3.6-3.7 amps 60Hz	1 Hp 115/208-230 V 1 Phase 14/6.8-7 amps 60Hz	2 Hp 115/208-230 V 1 Phase 18.8/10-9.4 amps 60Hz	5 Hp 208-230/460 V 3 Phase 15/13.2-6.6 amps 60Hz	10 Hp 208-230/460 V 3 Phase 28/26-13 amps 60Hz
	Shipping Weight (lbs)	275	425	750	1700	3250	6000

* Assumes mixing motor removed from filter. Minimum height required to drop propeller shaft and remove filter head.

** Assumes mixing motor removed from filter. Minimum height required to remove filter head with propeller shaft installed. Does not include excess height for installation of lifting device.

*** Filter Models PBF-50 and PBF-100 have two (2) outlet pipes oriented at 180 degrees.

**** Optional 3-Phase Motor available. Additionally, 50 Hz motors are also available.

Table 6.2 Dimensions & Specifications for the “Special” or High Flow PBF Model Bead Filters

	Specifications	PBF-5S	PBF-10S	PBF-25S	PBF-50S
A	Overall Height w/ motor installed	74"	~86"	103"	118"
B	Height to Motor Bracket	64"	75.375"	91"	104"
C	Height to top of filter cap	56"	67.5"	83"	95.5"
D	Outlet Pipe Height	52"	65"	79"	94.5"
E	Height to Filter Flange	48"	60"	73"	85.5"
F	Inlet/Sludge Outlet Height	26"	36"	40.5"	52"
G	Overall Diameter	34"	40"	59"	72"
H	Window Height	37"	47.5"	55"	73"
I	Emergency Drain Height	3"	3"	3.5"	4"
J	Min. Room Height Required*	78"	90"	107"	123"
K	Min. Room Height Required**	7 Feet	8.5 Feet	10 Feet	11.5 Feet
	Inlet/Sludge Discharge Pipe Size/Type	2" Fipt	3" Fipt	4" Fipt	6" Fipt
	Outlet Pipe Size/Type***	3" Fipt	3" Fipt	2- 4" Fipt	2- 6" Fipt
	Bead Capacity (ft ³)	5	10	25	50
	Specific Surface Area (ft ² /ft ³)	400	400	400	400
	Total Surface Area Available For Nitrification (ft ²)	2,000	4,000	10,000	20,000
	Maximum Allowable Hull Pressure (psi)	20	20	20	20
	Typical Pressure Drop Across Clean Filter Bed (psi)	2-3	2-5	3-5	3-6
	Maximum Flowrate (gpm)	100	200	300	600
	Typical Pump Horsepower	1/4 - 1/2	3/4 - 1 1/2	1 1/2 - 2	2 - 5 (2 pumps)
	Estimated Backwash Waterloss (gallons)/backwash	6-10	10-30	30-60	50-150
	Mixing Motor****	1/2 Hp 115/208-230 V 1 phase 7.4/3.6-3.7 amps 60Hz	1 Hp 115/208-230 V 1 Phase 14/6.8-7 amps 60Hz	2 Hp 115/208-230 V 1 Phase 18.8/10-9.4 amps 60Hz	5 Hp 208-230/460 V 3 Phase 15/13.2-6.6 amps 60Hz
	Shipping Weight (lbs)	450	750	1750	3350

* Assumes mixing motor removed from filter. Minimum height required to drop propeller shaft and remove filter head.

** Assumes mixing motor removed from filter. Minimum height required to remove filter head with propeller shaft installed. Does not include excess height for installation of lifting device.

*** Filter Models PBF-50 and PBF-100 have two (2) outlet pipes oriented at 180 degrees.

**** Optional 3-Phase Motor available. Additionally, 50 Hz motors are also available.

7.0 Filter Maintenance

Propeller-washed bead filters as with all mechanical devices do require regular maintenance. Table 7.1 lists the common maintenance procedures.

Table 7.1 Common Maintenance Procedures for Propeller-Washed Bead Filters

	Filter Part	Maintenance Procedure	Frequency
1.	Thrust Bearing Part # B.1.b	Grease with FDA approved food grade grease	Once every 2-4 months or as needed
2.	Mechanical Seals Part # B.1.a	Inspect: Replace when water is observed leaking from around propeller shaft.	Once every 1 year or as needed
3.	Thrust Bearing Part # B.1.b	Inspect: Should be replaced when mechanical seals are replaced or if showing signs of rust and corrosion.	Once every 1 years or as needed
4.	Shaft Bushing Part # B.1.e	Should be replaced when mechanical seals are replaced or if excessive vibration of propeller shaft is observed.	Once every 1 years or as needed
5.	Screen Part # B.1.d	Inspect: Although constructed of 316 stainless steel, corrosion and electrolysis can still occur especially in brackish and saltwater systems. (Refer to Section 7.1 for more details).	Once every 6 months if used in saltwater, once every 1 year if used in brackish water, once every 2 years if used in fresh water.
6.	Motor Support Part # B.1.c	Inspect: This part is constructed of Fiberglass; look for stress cracks caused by motor vibration.	Once every 1-2 years or as needed
7.	Pressure Relief* Valve, Table 1.4, Part O	Inspect/Test: Biofouling and corrosion can cause the pressure relieve valve to malfunction. Valve should be set to “pop-off” at a maximum of 20 psi.	Once every 1-2 months, more in brackish and saltwater environments

* Not applicable to Model PBF-3, PBF-25S, PBF-50, PBF-50S or PBF-100 since not supplied as standard equipment.

7.1 Special Maintenance Considerations

Efforts have been made to construct propeller-washed bead filters out of components suitable for both fresh and saltwater environments. The filter hull is constructed of food grade fiberglass (Section 1.1), the plumbing is Schedule 40 PVC, and all fasteners are 316 stainless steel as are all metal components which come in contact with water. **The use of 316 stainless steel, however, does not completely prevent the occurrence of electrolysis.** Regular inspection of the filter screen (Part # B.1.d), mechanical seal housing (Part # B.1.a), propeller shaft assembly (Part #B.3) and all fasteners which penetrate the filter housing and come in contact with water should be done at least once every year, more frequently in brackish and saltwater environments. Sacrificial anodes, such as those used on boats, **are not recommended** since most are constructed of **zinc, which is toxic to fish.**

8.0 Glossary

Acclimation - the process of establishing a healthy bacterial film in a biofilter.

Alkalinity - the ability of water to resist pH change upon the addition of acids.

Backwashing - the process of cleaning the media in a filter by hydraulic, pneumatic, or mechanical agitation.

Biochemical Oxygen Demand (BOD) - a measure of the amount of oxygen demanding material in water. BOD is an indirect measure of the amount of biodegradable organic matter in recirculating systems.

Biofilm - a thin layer of bacteria that coats the media in a biofilter.

Biofloc - clusters of heterotrophic and/or nitrifying bacteria that can form large visible particles in the water.

Biofiltration - the use of bacteria, fungi, or algae to remove dissolved wastes from waters.

Biomass - the weight of biofloc, plants, or fish being measured.

BOD - biochemical oxygen demand.

Carbonate Alkalinity - the level of alkalinity attributed to the bicarbonate and carbonate ion.

Chemical Flocculation - a process used to remove fine suspended solids and colloidal particles by inducing the chemical formation of flocs that entrap small particles as they form or sink.

Clarification - the removal of particulate solids from water usually by settling or filtration.

Clarifiers - tanks or filters specifically designed to remove suspended solids.

Colloidal - very small particles that exhibit characteristics between a suspended solids and a dissolved chemical.

Degasification the process of stripping supersaturated gases (usually carbon dioxide or nitrogen) from the water.

Density - loosely used to describe the population of fish (or animals) per unit volume (pounds of fish per gallon) or per area (crabs per square foot) that a system supports.

Diffuser - usually a piece of perforated pipe designed to distribute flows and reduce velocities at the point of water injection.

Effluent - flowing out of, i.e., the pump's effluent is the water discharged from the pump.

Enzymatic - used to describe chemical reactions which are dependent on the use of enzymes.

Enzymes - complex protein molecules that are used to accelerate chemical reactions in living organisms.

Fipt - female iron pipe thread, also the standard female pipe thread used on PVC and fiberglass plumbing fittings.

Flange - a circular flat collar, which is attached to the end of a piece of pipe or equipment to facilitate a watertight attachment with bolts.

Heterotrophic - a classification of bacteria that extract carbon (and in this application energy) from the breakdown of organic matter.

Heterotrophs - see heterotrophic.

Hydraulic - of or related to the behavior of fluids.

Influent - flowing into, i.e., the filter's influent is the water flowing into the filter.

Influx - inflow.

Ion - an atom or molecule that has lost or gained an electron so that it exhibits a positive or negative charge.

Loading - a term used to express the relative amount of waste that a filter or system must process.

Manifold - a section of pipe used to collect or distribute waters from/to several locations.

Mipt - male iron pipe thread, also the standard male pipe thread used on PVC and fiberglass plumbing fittings.

National Pipe Thread - standardized tapered thread used for iron, galvanized and plastic plumbing fittings.

Nitrate - the nitrate ion, NO_3^- , is a stable nitrogen form produced as an end product of the nitrification process widely used as a fertilizer for plants. It is not toxic to most fresh water and marine species at concentrations of the order of 100 mg-N/l.

Nitrification - the process of converting ammonia to nitrate through the actions of bacteria.

Nitrite - the nitrite ion, NO_2^- , is an intermediate product formed in the nitrification process. It is highly toxic to a wide variety of fresh water and marine species in concentrations of the order of 1 mg-N/l.

NPT - National pipe thread.

Organic Loading - the amount of organic waste applied to a filter usually expressed in terms of pounds of feed per cubic foot or more precisely pounds of BOD per cubic foot.

Packed Column - an elevated stack of media through which water is cascaded and air blown to facilitate oxygen replenishment or carbon dioxide removal from recirculating waters.

Planktonic - suspended or swimming in the water column (i.e. planktonic algae).

Shear Forces - forces generated by the differential velocities of adjacent bodies of fluids and or solids.

Substrate - the compound a bacteria converts or consumes as its principle energy (food) source.

Suspended Solids - see Total Suspended Solids.

Sludge a thick, pudding like, mixture of solids and water usually composed of partially decomposed fish feces and bacterial biofloc.

Slurry - a thick yet fluid mixture of sludge and water.

TAN - total ammonia nitrogen.

Total Alkalinity - the measure of water's ability to absorb acids (hydrogen ions) usually attributed to chemical interactions with the hydroxide ion (OH^-), the carbonate ion ($\text{CO}_3^{=}$), & the bicarbonate ion (HCO_3^-).

Total Ammonia Nitrogen (TAN) - the sum of the concentration of ammonia (NH_3) and the ammonium ion (NH_4^+) expressed in milligrams of nitrogen per liters (mg-N/l). This term is used because the ionic forms are pH dependent.

Total Suspended Solids - a measure of the amount of particulate solids found in water usually determined by filtration of a sample through a filter paper with a pore size of about 1 micron.

TSS - total suspended solids.

Water Hammer - a sudden hydraulic force resulting from the momentum of moving water caused by abrupt interruptions in flow (i.e. sudden valve closure).

Waterloss - a measure of the amount of water that is removed from the system or lost to evaporation.

9.0 References

Allain, P. A. 1988. Ion Shifts and pH Management in High Density Shedding Systems for Blue Crabs (Callinectes sapidus) and Red Swamp Crawfish (Procambarus clarkii), Master's Thesis, Louisiana State University, Baton Rouge, Louisiana, 77 pp.

Downing, A. L., H.A. Painter and G. Knowles. 1964. Nitrification in the Activated Sludge Process, Journal of the Institute for Sewer Purification, 130: 130-158.

Knowles, G., Downing, A.L. and Barrett, M.J. 1965. Determination of Rate Constants for Nitrifying Bacteria with the aid of an Electronic Computer, J. Gen. Microbiology, Vol. 38.

Manthe, D. P., R. F. Malone, and S. Kumar. 1985a. Elimination of Oxygen Deficiencies Associated with Submerged Rock Filters used in Closed, Recirculating Aquaculture Systems, In Closed Blue Crab Shedding Systems, National Symposium on the Soft-Shelled blue Crab Fisheries, P.M. Perry and R.F. Malone, eds., pp. 49-55.

Manthe, D. P., R. F. Malone, and H. Perry. 1985b. Water Quality Fluctuations in Response to Variable Loading in a Commercial Closed Blue Crab Shedding System, Journal of Shellfish Research, Vol 3:2: pp. 175-182.

Paz, J. D. 1984. The Effects of Borderline Alkalinity on Nitrification in Natural Water Systems, Ph.D. Dissertation, Polytechnic Institute of New York, 125 pp.

Sharma, B. and R. C. Alhert. 1977. Nitrification and Nitrogen Removal, Water Research, 11: 897-925.

Shieh, W. K. and E. J. LaMotte. 1979. Effect of Initial Substrate Concentration on the Rate of Nitrification in Batch Experiment, Biotechnology and Bioengineering, 21: 201-211.

10.0 Propeller-Washed Bead Filter Tech Tips

1. Unexpected loss of beads from a PBF filter may result from:
 - A. When initially starting up a PBF unit, it is common to have a small number of small, undersized beads pass through the bead retention screen and into the culture tank. While we use virgin plastic bead media in all of our filters, we cannot totally eliminate undersized beads.
 - B. The bottom screen on most PBF filters is not screened. Failure to install a siphon break as part of the external plumbing assembly can result in the **loss of beads** from the filter through the drain line due to a siphon. If the siphon break is installed properly, the water level in the filter cannot drop below the inlet fitting on the side of the filter, thus preventing the beads from being drained from the filter.
 - C. Over washing the beads or extended operation of the mixing motor can result in bead loss. If the mixer is run for an extended period of time, beads are forced to the bottom of the filter and become captured in the diffuser. If you suspect this is occurring or have reason to run the mixer for an extended period of time, you can eliminate the bead loss by turning on the recirculation pump for 5 seconds to force any trapped beads from the diffuser.
2. **The mixing motor should never be run unless the filter is full of water and the circulation pump is turned off.** Running the mixing motor even for very short periods of time without water will result in overheating of the bushing in the shaft support pipe. If this occurs you must replace the bushing.
3. If sludge drains from the filter rapidly then slows to a trickle it is generally due to lack of an air break on the top of the filter. This typically occurs when the effluent line is submerged in the culture tank and there is no way for air to enter the filter as the sludge is drained from the filter. Installing a check or manual valve in a TEE on the effluent line easily solves this problem.
4. If you experience cloudy water, you may have a small air leak on the suction side of your pump or and air stone may have migrated to the vicinity of your pump intake. Bubbles accumulating under the bead bed eventually channel upwards, releasing solids. If you suspect this may be causing a problem in your system you can tighten all threaded fitting on the intake side of your pump, wipe silicon sealant on all pipe joints and/or move the air stone(s) away from the pump intake.
5. Never open the unscreened emergency bottom drain unless your pump is turned off and your filter is full of water. This valve is not intended to use during normal backwashing of the filter, it is only to be used periodically to check and see if sludge is accumulating in the bottom of the filter or to completely drain the water from the filter. If this valve is inadvertently left open, you can and will drain all the beads from your filter.
6. If when you turn on the mixing motor for the first time the beads do not mix, check the direction of motor rotation. The motor should be spinning clockwise. (From right to left)

11.0 Propeller-Washed Bead Filter Automated Controllers And Accessories

- φ Backwash Interval Controlled by Time.
- φ Allows 1 hour to 7 days Backwash Interval.
- φ Fail Safe Operation. If sludge valve fails to close, pump will not turn on after backwash.
- φ Loud 75 db Alarm.
- φ One Button Manual Override.

- φ Special Mode to Allow you to use your Circulation Pump to Drain your System.
- φ Easy to Install/Retrofit on to Existing Filters.
- φ Tried and Test for Over 5 Years.
- φ Internal Circuit Breakers allow you to more easily Power Down the Unit.
- φ NEMA 4X Enclosure with Hinged Door for Easy Access and Installation.
- φ Terminal Strips to Allow Easier Connection of Valves and Pumps

FILTER CONTROLLERS

Filter Controller Model	Description
ASTPW1 ¹	Propeller Filter Controller
ASTPW4-1 ²	Propeller Filter By-Pass Controller for use with 3-way actuated ball valves; uses ONE Std. Wired 2-way Sludge Valve with extra limit switch.
ASTPW4-2 ³	Propeller Filter By-Pass Controller for use with 3-way actuated ball valves; uses TWO Std. Wired 2-way Sludge Valve with extra limit switches.

1. Requires one 120 v (AST Wired) Electric Actuated Ball Valve and two Motor Starters or Pump Start Relays with 110 v coils.
2. Requires one 120 v (Std. Wired) Electric Actuated Ball Valve, one 120 v Electric Actuated 3-Way Ball Valve and one Motor Starter or Pump Start Relay with 115 v coil.
3. Requires two 120 v (Std. Wired) Electric Actuated Ball Valves, one 120 v Electric Actuated 3-Way Ball Valve and one Motor Starter or Pump Start Relay with 115 v coil and requires one external double pole, double throw Plug-In Relay (Newark Part Number: 17M3078)

ELECTRIC ACTUATED BALL VALVES

Spears 120v Electric Actuated Ball Valves	Size/Type
C-E1406-007 - AST Wired	3/4" (t X t)
C-E1406-010 - AST Wired	1" (t x t)
C-E1506-012 - AST Wired	1.25" (t x t)
C-E1506-015 - AST Wired	1.5" (t x t)
C-E1506-020 - AST Wired	2" (t x t)
Asahi Electromni120v Actuated Ball Valves	Size/Type
AST-206010 - AST Wired	1" (t x t)
AST-206012 - AST Wired	1.25" (t x t)
AST-206015 - AST Wired	1.5" (t x t)
AST-206020 - AST Wired	2" (t x t)
Hayward 120v 3-Way Electric Actuated Ball Valves	Size/Type
HY3W10ACT - Standard Wired	1" (t x t x t)
HY3W15ACT - Standard Wired	1.5" (t x t x t)
HY3W20ACT - Standard Wired	2" (t x t x t)
HY3W30ACT - Standard Wired	3" (t x t x t)
HY3W40ACT - Standard Wired	4" (t x t x t)

Motor Starter with 115 v coil ¹	Voltage/ Phase	Hp	Required Heater ²
.5-3MS1151	115 v / single	.5	E51
		.75	E53
		1	E55
		1.5	E60
		2	E61
		2.5	E61
		3	E65
Motor Starter with 115 v coil ¹	Voltage/ Phase	Hp	Required Heater ²
.5-3MS2301	230 v / single	.5	E51
		.75	E51
		1	E51
		1.5	E51
		2	E52
		2.5	E51
		3	E54
2-5MS2303 ³	230 v / three	2	E48
		3	E52
		5	E54
2-5MS4603 ³	460 v / three	2	E38
		3	E42
		5	E44
10MS2303 ³	230 v / three	10	E65
10MS4603 ³	460 v / three	10	E54
E-Series Heater ³			

Siemens-Furnas Magnetic MOTOR STARTERS with Thermal Protection

1. Motor starts are mounted in NEMA 1 enclosure. Are UL, CSA listed?
2. You must select the appropriate size HEATER to match the amp draw of the motor or pump. Heaters are not included with the motor starter.
3. Three phase motors require THREE heaters. Single-phase motor require ONE heater.

PUMP START RELAYS

Pump Start Relay with 115v Coil ¹	Pump Motor Hp (MAX)			
	Single Phase ²		Three Phase ³	
	120v	230v	200/230v	460v
PSR123-120	1 Hp	2 Hp	3 Hp	5 Hp
PSR575-120	2 Hp	5 Hp	7.5 Hp	15 Hp

1. Contactors are UL and UL Canada rated. Mechanical life up to 10 M operations. Gray Noryl Thermoplastic Plastic NEMA 4X enclosure of indoor or outdoor use. Gasketed cover. 8 conduit knockouts. Stainless steel screws. Includes sealing plugs to waterproof mounting screws.
2. Single Phase systems require **motor overload protection** within the motor.

3. Three Phase Systems require either **motor overload protection** within the motor or external **motor overload protection**.

12.0 Propeller-Washed Bead Filter Options

Part #	Description
SCREEN11.5"-TITANIUM	11.5" dia. Titanium screen for PBF-3
SCREEN16"-TITANIUM	16" dia. Titanium screen for PBF-5
SCREEN18"-TITANIUM	18" dia. Titanium screen for PBF-5S and PBF-10
SCREEN24"-TITANIUM	24" dia. Titanium screen for PBF-10S and PBF-25
SCREEN36"-TITANIUM	36" dia. Titanium screen for PBF-25S and PBF-50
SCREEN48"-TITANIUM	48" dia. Titanium screen for PBF-50S and PBF-100
PBF-EXPLMB4	4" External plumbing kit for PBF-25S and PBF-50, includes saltwater compatible 2" pressure relief valve.
PBF-EXPLMB6	6" External plumbing kit for PBF-50S and PBF-100, includes saltwater compatible 2" pressure relief valve.
BEADS-55LBBAG	Bead Media (55 lb bag = 1.57 cubic feet)
BEAD-ENMEDIA2-FT3	Enhanced Nitrification Media per cubic foot when purchased without bead filter
BEAD-ENMEDIA2-FT3	Enhanced Nitrification Media per cubic foot when purchased with a bead filter
PBF31/3HP50HZ1PUP	50 Hz mixing motor upgrade for PBF-3
PBF51/2HP50HZ1PUP	50 Hz mixing motor upgrade for PBF-5 and PBF-5S
PBF101HP50HZ1PUP	50 Hz mixing motor upgrade for PBF-10 and PBF-10S
PBF252HP50HZ1PUP	50 Hz mixing motor upgrade for PBF-25 and PBF-25S
PBF505HP50HZ1PUP	50 Hz mixing motor upgrade for PBF-50 and PBF-50S
PBF10010HP50HZ1PUP	50 Hz mixing motor upgrade for PBF-100

* All prices subject to change without notice. Prices do not include shipping or crating.

13.0 Propeller-Washed Bead Filter Replacement Parts

Part #	Description
SCREEN11.5"-316SS	11.5" dia. 316 stainless steel screen for PBF-3
SCREEN16"-316SS	16" dia. 316 stainless steel screen for PBF-5
SCREEN18"-316SS	18" dia. 316 stainless steel screen for PBF-5S and PBF-10
SCREEN24"-316SS	24" dia. 316 stainless steel screen for PBF-10S and PBF-25
SCREEN36"-316SS	36" dia. 316 stainless steel screen for PBF-25S and PBF-50
SCREEN48"-316SS	48" dia. 316 stainless steel screen for PBF-50S and PBF-100
MN.3318ES1BB56CFL	1/3 hp, single phase mixing motor for PBF-3
MO587-3PH	1/3 hp, three phase mixing motor for PBF-3

MN.5018ES1BB56CFL	1/2 hp, single phase mixing motor for PBF-5 and PBF-5S
MO588-3PH	1/2 hp, three phase mixing motor for PBF-5 and PBF 5S
MN590	1 hp, single phase mixing motor for PBF-10 and PBF-10S
MO590-3PH	1 hp, three phase mixing motor for PBF-10 and PBF 10S
MN35E022R185	2 hp, single phase mixing motor for PBF-25 and PBF-25S
MOV3558	2 hp, three phase mixing motor for PBF-25 and PBF 25S
MOCL3612TM	5 hp, single phase mixing motor for PBF-50 and PBF-50S
MNVM3615T	5 hp, three phase mixing motor for PBF-50 and PBF 50S
MOVL3712T-50	10 hp, 50HZ, single phase mixing motor for PBF-100
MNVM3714T	10 hp, 60HZ, three phase mixing motor for PBF-100
PBF-EXPLMB1.5	External plumbing kit for PBF-5
PBF-EXPLMB2	External plumbing kit for PBF-5S and PBF-10
PBF-EXPLMB3	External plumbing kit for PBF-10S and PBF-25
PBF-SK5/8	5/8" replacement seal kit: includes (2) 5/8" mechanical seals, (1) 5/8" thrust bearing, (1) 5/8" support bushing (for PBF-3, PBF-5 and PBF-5S)
PBF-SK3/4	3/4" replacement seal kit: includes (2) 3/4" mechanical seals, (1) 3/4" thrust bearing, (1) 3/4" support bushing (for PBF-10, PBF-10S, PBF-25 and PBF-25S)
PBF-SK7/8	7/8" replacement seal kit: includes (2) 7/8" mechanical seals, (1) 7/8" thrust bearing, (1) 7/8" support bushing (for PBF-50, PBF-50S, and PBF-100)
PBF-SGK6IN	6" replacement site glass kit: includes site glass, gasket, and fasteners. For PBF-3, PBF-5, PBF-5S, PBF-10, PBF-10S, PBF-25, PBF-25S
PBF-SGK8IN	8" replacement site glass kit: includes site glass, gasket, and fasteners. For PBF-50, PBF-50S, and PBF-100

13.0 Propeller-Washed Bead Filter Replacement Parts (continued)

RVI0507T-10PSI	3/4" PVC Pressure Relief Valve with SS poppet. Set 10 psi.
RVI0510T-20PSI	1" PVC Pressure Relief Valve with SS poppet. Set 20 psi.
RVI0512T-20PSI	1-1/4" PVC Pressure Relief Valve with SS poppet. Set 20 psi.
RVI0515T-20PSI	1-1/2" PVC Pressure Relief Valve with SS poppet. Set 20 psi.
RVI0520T-20PSI	2" PVC Pressure Relief Valve with SS poppet. Set 20 psi.
6X072	5/8" Love-joy coupling
4X191	3/4" Love-joy coupling
6X075	7/8" Love-joy coupling
1X407	Love-joy coupling Insert

GSK16X12RBNE12N	neoprene head gasket for PBF-3
GSK11.5X8-5/8RBNE12N	neoprene head gasket for PBF-5
GSK18X13RBNE12N	neoprene head gasket for PBF-5S and PBF-10
GSK24X18RBNE12N	neoprene head gasket for PBF-10S and PBF-25
GSK36X30RBNE12N	neoprene head gasket for PBF-25S and PBF-50
GSK48X42RBNE12N	neoprene head gasket for PBF-100
AEX0015	orange motor guard with spring for all model PBF's
AST2141GXB30	0-30 psi, 2.5" Liquid Filled SS pressure gauge, 1/4" NPT lower
PBF-3SHAFT, PBF-5SHAFT, PBF-5SPSHAFT, PBF-10SHAFT, PBF-10SPSHAFT, PBF-25SHAFT, PBF-25SPSHAFT, PBF-50SHAFT, PBF-50SPSHAFT, PBF-100SHAFT	PBF mixing shafts: Please call for pricing: AST representative will need to know Filter Serial #

14.0 Recommended Pumps for Propeller-Washed Bead Filters

<i>Model PBF-3</i> 30 gpm maximum flow rate		
Part #	Description	
4500SEQ21	Multi-Duti MFG Sequence 1000. 30 gpm @ 16' TDH. 110/230 volts, 253 watts, 1/6 Hp. TEFC Motor, 1750 rpm. 1.5" FIPT suction and discharge. Includes 8' 115 volt power cord. Saltwater seal and hardware available add \$25.71 to Dealer Price and \$36.00 to List Price. Optional strainer baskets available see below. 3 year warranty.	
5100SEQ22	Multi-Duti MFG Sequence Pro 1000. 30 gpm @ 20' TDH. 110/230 volts, 290 watts, 1/4 Hp. TEFC Motor, 1550 rpm. 1.5" FIPT suction and discharge. Includes 8' 115 volt power cord. Saltwater seal and hardware available. Optional strainer baskets available see below. 3 year warranty.	
LT1/6L	Sta-Rite LT 1/6 Centrifugal Pump. 30 gpm @ 18' TDH. 115 volts, 4.5 amps, 1/6 Hp. ODP Motor, 3450 rpm. 1.5" FIPT suction and discharge. No power cord, not saltwater compatible. A great inexpensive pump!	
AquaFlo-1/8	AquaFlo Centrifugal Pump. 30 gpm @ 13' TDH. 110 volts, 1.7 amps, 1/8 Hp. ODP Motor, 1750 rpm. 1.5" FIPT suction and discharge. Includes 3' 115 volt power cord. Saltwater seal available. Optional strainer baskets available see below. 1 year warranty.	
0301-DRA-1/4	0301-DRA-1/4: Dragon Series Maximum Performance Pump with Integral Strainer Basket. 1/4 hp, 115/230 volts, 60 Hz, TEFC motor, 1800 rpm. 2" union suction and discharge providing 30 gpm @ 17' TDH. Includes 6' 115 volt power cord. 3 year warranty.	
2ST2C4D4	Goulds NPE end suction centrifugal pump, size 1.25 x 1.5-6 with a 4 5/8" dia. impeller. Stainless steel construction and mechanical seal, .5 hp, 1750 rpm, closed couple, single phase, 115/230 volt, 60 Hz, TEFC motor. Pump will provide 30 gpm @ 17 ft TDH. Ship weight: 31 lbs	
2ST2C5D4	Goulds NPE end suction centrifugal pump, size 1.25 x 1.5-6 with a 4 5/8" dia. impeller. Stainless steel construction and mechanical seal, .5 hp, 1750 rpm, closed couple, 3-phase, 230/460 volt, 60 Hz, TEFC motor. Pump will provide 30 gpm @ 17 ft TDH. Ship weight: 31 lbs.	
WG-15KIT	Strainer Basket for Aqua Flo pumps with a 1.5" suction. Has 1.5" (1/2) union outlet with 1.5" inlet.	
1000.7711.5	Strainer Basket for pumps with 1.5" suction. Has 1.5" FIPT inlet/outlet. Manufactured by Waterway.	

WG-20KIT	Strainer Basket for pumps with 2" suction. Has 2" FIPT inlet/outlet.		
----------	--	--	--

Model PBF-5 50 gpm maximum flow rate			
Part #	Description		
6100SEQ23	Multi-Duti MFG Sequence 1000. 50 gpm @ 19' TDH. 110/230 volts, 396 watts, 1/3 Hp. TEFC Motor, 1750 rpm. 1.5" FIPT suction and discharge. Includes 8' 115 volt power cord. Saltwater seal and hardware available. Optional strainer baskets available see below. 3 year warranty.		
JWPA5DL-2A	Sta-Rite JWP Series Efficient Self Priming Centrifugal Pump with integral strainer basket. 50 gpm @ 30' TDH. 115 volts, 9 amps, 3/4 Hp. ODP Motor, 3450 rpm. 1 1/2" FIPT suction and 1 1/2" union discharge. No power cord, saltwater compatible. Includes pump mounting base part # 77701-0100.		
AFP-120	Pentair Waterfall Specialty Pump: Cat # 340351. Pump casing molded of thermoplastics with integral strainer basket. 2" NPT suction and discharge ports. Pump motor is single-phase 115/230v, 60 Hz, 8/4 amps providing 50 gpm @ 23 TDH. 3 year warranty.		
0305-DRA-10	0305-DRA-10: Dragon Series Maximum Performance Pump with Integral Strainer Basket. 1 hp, 115/230 volts, 60 Hz, TEFC motor, 1800 rpm. 2" union suction and discharge providing 50 gpm @ 28' TDH. Includes 6' 115 volt power cord. 3 year warranty.		
2ST2C4H4	Goulds NPE end suction centrifugal pump, size 1.25 x 1.5-6 with a 5.5" dia. impeller. Stainless steel construction and mechanical seal, .5 hp, 1750 rpm, closed couple, single phase, 115/230 volt, 60 Hz, TEFC motor. Pump will provide 50 gpm @ 22.5 ft TDH. Ship weight: 31 lbs.		
2ST2C5H4	Goulds NPE end suction centrifugal pump, size 1.25 x 1.5-6 with a 5.5" dia. impeller. Stainless steel construction and mechanical seal, .5 hp, 1750 rpm, closed couple, 3-phase, 230/460 volt, 60 Hz, TEFC motor. Pump will provide 50 gpm @ 22.5 ft TDH. Ship weight: 31 lbs.		
WG-15KIT	Strainer Basket for Aqua Flo pumps with a 1.5" suction. Has 1.5" (1/2) union outlet with 1.5" inlet.		
1000.7711.5	Strainer Basket for pumps with 1.5" suction. Has 1.5" FIPT inlet/outlet. Manufactured by Waterway.		
WG-20KIT	Strainer Basket for pumps with 2" suction. Has 2" FIPT inlet/outlet.		

Models PBF-5S and PBF-10 100 gpm maximum flow rate			
Part #	Description		
3ST1F4D4	Goulds NPE end suction centrifugal pump, size 1.5 x 2-6 with a 4 1/16" dia. impeller. Stainless steel construction and mechanical seal, 1.5 hp, 3500 rpm, closed couple, single phase, 115/230 volt, 60 Hz, TEFC motor. Pump will provide 100 gpm @ 30 ft TDH. Ship weight: 44 lbs.		
3ST1F5D4	Goulds NPE end suction centrifugal pump, size 1.5 x 2-6 with a 4 1/16" dia. impeller. Stainless steel construction and mechanical seal, 1.5 hp, 3500 rpm, closed couple, 3-phase, 230/460 volt, 60 Hz, TEFC motor. Pump will provide 100 gpm @ 30 ft TDH. Ship weight: 36 lbs.		
MPEA6FL	MPEA6FL Sta-Rite Dyna-Max Energy Efficient Self Priming Centrifugal Pump with integral strainer basket. 100 gpm @ 42' TDH. 110/230 volts, 16/8 amps, 1.5 Hp. ODP Motor, 3450 rpm. 2" FIPT suction and discharge. No power cord, saltwater compatible. Set of two 2" half unions available.		

WFE-4	Pentair WhisperFlo High Performance Centrifugal Pump with integral strainer basket. Cat. # 011513. 2" FIPT suction and discharge. Pump motor 1 hp, ODP, 115/208-230 volts, 60 Hz, 3450 rpm, 14.8/7.8-7.4 amps providing 100 gpm @ 40' TDH.		
-------	--	--	--

Models PBF-10S and PBF-25 200 gpm maximum flow rate			
Part #	Description		
6SH2G4E0	Goulds SSH end suction centrifugal pump, size 2.5 x 3-6 with a 6 3/8" dia. impeller. Stainless steel construction and mechanical seal, 2 hp, 1750 rpm, closed couple, single phase, 115/230 volt, 60 Hz, TEFC motor. Pump will provide 200 gpm @ 23 ft TDH. Ship weight: 105 lbs.		
6SH2G5E0	Goulds SSH end suction centrifugal pump, size 2.5 x 3-6 with a 6 3/8" dia. impeller. Stainless steel construction and mechanical seal, 2 hp, 1750 rpm, closed couple, 3-phase, 230/460 volt, 60 Hz, TEFC motor. Pump will provide 200 gpm @ 23 ft TDH. Ship weight: 82 lbs.		
B74813	Berkley end suction centrifugal pump, size 4" npt suction, 3" npt discharge with a 5.938" dia. silicon bronze impeller with non-overloading trims, mechanical seal, 2 hp, 1800 rpm, closed couple, 3-phase, 230/460 volt, 60 Hz, ODP motor. Pump will provide 200 gpm @ 28 ft TDH. Ship weight: 125 lbs.		
B60766	Berkeley type "B" single stage self-priming motor drive pump: Model # B3TPKS/ Cat. # B60766: 3" NPT suction/ discharge, 6.594" dia. x .750" cast iron impeller, cast iron pump case and bracket, EPDM seal with ceramic carbon and stainless steel. Electric motor: 3 hp, 3-phase, 208-230/ 460 volt, 9.4-9.0/ 4.5 amp, 60 Hz, 1800 rpm providing 200 gpm @ 31 ft. Weight: 190 lbs.		
B60765	Berkeley type "B" single stage self-priming motor drive pump: Model # B3TPKS/ Cat. # B60765: 3" NPT suction/ discharge, 6.594" dia. x .750" cast iron impeller, cast iron pump case and bracket, EPDM seal with ceramic carbon and stainless steel. Electric motor: 3 hp, single-phase, 230 volt, 60 Hz, 1800 rpm providing 200 gpm @ 31 ft. Weight: 190 lbs.		

Models PBF-25S and PBF-50 300 gpm maximum flow rate			
Part #	Description		
6SH2H4A0	Goulds SSH end suction centrifugal pump, size 2.5 x 3-6 with a 7.5" dia. impeller. Stainless steel construction and mechanical seal, 3 hp, 1750 rpm, closed couple, single phase, 115/230 volt, 60 Hz, TEFC motor. Pump will provide 300 gpm @ 23 ft TDH. Ship weight: 146 lbs.		
6SH2H5A0	Goulds SSH end suction centrifugal pump, size 2.5 x 3-6 with a 7.5" dia. impeller. Stainless steel construction and mechanical seal, 3 hp, 1750 rpm, closed couple, 3-phase, 230/460 volt, 60 Hz, TEFC motor. Pump will provide 300 gpm @ 23 ft TDH. Ship weight: 121 lbs.		

B66583S	Berkley end suction centrifugal pump, size 4" npt suction, 3" npt discharge with a 6.188" dia. Silicon bronze impeller with non-overloading trims, mechanical seal, 5 hp, 1800 rpm, closed couple, 3-phase, 230/460 volt, 60 Hz, ODP motor. Pump will provide 300 gpm @ 33 ft TDH. Ship weight: 200 lbs.		
B54630	Berkeley type "B" single stage self-priming motor drive pump: Model # B4TPKS/ Cat. # B54630: 4" NPT suction/ discharge, 6-19/32" dia. x 1" BA full cast iron impeller, cast iron pump case and bracket, EPDM seal with ceramic carbon and stainless steel. Electric motor: 3 hp, single-phase, 230 volt, 60 Hz, 1800 rpm providing 300 gpm @ 29 ft. Weight: 185 lbs.		

**Models PBF-50S and PBF-100
600 gpm maximum flow rate**

Part #	Description		
23SH2J4FO	Goulds SSH end suction centrifugal pump, size 3 x 4-8 with a 7.5" dia. impeller. Stainless steel construction and mechanical seal, 5 hp, 1750 rpm, closed couple, single-phase, 230 volt, 60 Hz, TEFC motor. Pump will provide 600 gpm @ 22 ft TDH. Ship weight: 208 lbs.		
23SH2K5C0	Goulds SSH end suction centrifugal pump, size 3 x 4-8 with an 8 7/16" dia. impeller. Stainless steel construction and mechanical seal, 7.5 hp, 1750 rpm, closed couple, 3-phase, 230/460 volt, 60 Hz, TEFC motor. Pump will provide 600 gpm @ 30 ft TDH. Ship weight: 224 lbs.		
B62581S	Berkley end suction centrifugal pump, size 6" x 11" flanged suction, 5" x 10" flanged discharge with a 7.00" dia. Silicon bronze impeller with non-overloading trims, mechanical seal, 10 hp, 1800 rpm, closed couple, 3-phase, 230/460 volt, 60 Hz, ODP motor. Pump will provide 600 gpm @ 36 ft TDH. Ship weight: 330 lbs.		

**Models PBF-100S
1200 gpm maximum flow rate**

Part #	Description		
B69546	Berkley end suction centrifugal pump: B6ZPLS, size 8" flange suction, 6" flange discharge with a 8.18" dia. silicon bronze impeller with non-overloading trim, mechanical seal, 15 hp, 1750 rpm, closed couple, 3-phase, 230/460 volt, 60 Hz, ODP motor. Pump will provide 1200 gpm @ 35 ft TDH.		

LIMITED WARRANTY

Aquaculture Systems Technologies, LLC, (AST) warrants the material and workmanship to be free of defects under designated use and normal service on its **Propeller-Washed Bead Filters** for a period of ninety (90) days from the date of shipment. All warranty claims must be presented in writing to AST within one hundred twenty (120) days from date of shipment by AST. Normal use and service requires the following:

1. The filter be installed and operated according to the installation and operational instructions supplied by the manufacturer.
2. That excessive weight due to heavy pipes, valves, etc. should not be carried by the inlets or outlets.
3. That the filter hull pressure is at no time allowed to exceed the maximum pressure rating as specified by the manufacturer.

This warranty applies only to the original purchase price, and is good only when the total payment for the equipment has been received. The limited warranty (expressed or implied) during the warranty period shall consist of the repair or replacement of the items of manufacture, at the discretion of **AST**, and said warranty applies only to the original purchaser. This warranty is void if the items are damaged by negligence or accident after purchase; used for other than the intended purpose; altered; repaired at other than an authorized service center; or used with other items that affect the integrity, performance, or safety of these items. Liability does not cover indirect or consequential cost, including materials lost, labor or installation/reinstallation cost, injury, property damage, or damages caused by mishandling. Returns for repairs must be pre-approved and the return authorization number prominently displayed on the outside of the shipping container. Returns will not be accepted without a "return authorization number". Returns for repair should be sent to the following address "FREIGHT PREPAID":

Aquaculture Systems Technologies, LLC
P.O. Box 15827
New Orleans, LA 70175
108 Industrial Ave.
Jefferson, LA 70121
(504) 837-5575 phone
(504) 837-5585 fax
Info@BeadFilters.com e-mail

Manufacturer's liability for incidental or consequential damages is specifically excluded to the full extent permitted by the applicable law. This warranty gives you specific legal rights, and you may also have other rights, which may vary from state to state. **THIS WARRANTY IS EXCLUSIVE OF ALL OTHER IMPLIED WARRANTIES INCLUDING MERCHANTABILITY AND FITNESS FOR A PARTICULAR PURPOSE.**

Please complete the following for your records before sending in your warranty card to validate your warranty.

Filter Model: _____

Serial Number: _____

Date of Purchase: _____

Purchased From: _____