



**BEAD FILTER MODEL
HPPG-10 to HPPG-50**



108 Industrial Avenue
New Orleans, LA 70121
Phone (504) 837-5575
Fax (504) 837-5585
Info@astfilters.com
www.ASTfilters.com

Table of Contents

Introduction to the HPPG Series	2
Operation	2
Backwash Operation Overview	0
HPPG Bead Filter Major Components	3
Installation	4
Pump Configuration	4
Airlift Configuration	6
Backwash Air Pump.....	8
General Setup Directions	10
Adjusting your Backwash Frequency	11
Sludge Drainage Assembly	14
Air Pump Requirements for Backwashing	15
Backwash Frequency.....	15
Troubleshooting (Filter Function)	17
Trouble Shooting for Recirculating Aquaculture Applications.....	20
Sulfide Production.....	21
Filter Acclimation	22
Appendix A: The Science behind Bioclarification.....	27
Clarification	27
Biofiltration	29
Warranty.	32



Introduction to the HPPG Series

The High Pressure *PolyGeyser*[®] (HPPG) bead filter series is the newest addition to Aquaculture Systems Technologies' line of bead filters. Patented (U.S. Patent #9,227,863 Patent Pending , European Patent #0977713B & Canadian Patent #2,287,191) fully exploits the biofilm protection provided by our Enhanced Nitrification (EN) Bead Media in a durable fiberglass hull. Designed as “bioclarifiers” capable of performing both biological and mechanical filtration, *PolyGeyser*[®] Bead Filters are capable of handling biological loads 50% to 100% higher than our Bubble Bead or Propeller Bead Filters equipped with standard bead media. Additionally, the *PolyGeyser*[®] Bead Filters are virtually immune to clogging and caking, since they are backwashed pneumatically at a high frequency. These High Pressure *PolyGeyser*[®] (HPPG) Bead Filters recycle their own backwash waters. The HPPG filters are the bioclarifier of choice for commercial aquaculture and wastewater applications dealing with high organic loads.

Operation

The *PolyGeyser*[®] Bead Filter stands apart from AST's other Bead Filter technologies primarily through its automatic pneumatic backwash mechanism. Water is introduced below the bed of packed EN bead media and travels upward through the filtration chamber where mechanical and biological filtration takes place. Simultaneously, air is slowly introduced into the air charge chamber at a constant, predetermined rate to achieve the desired backwash frequency. Once the charge chamber has reached capacity, the pneumatic trigger fires, releasing the entrained air from the charge chamber below the media bed. The sudden release of air from the charge chamber causes the beads to mix, roll and “drop” as the air agitates the beads.

The circulation pump/airlift operates continually, which ensures that the filter chamber begins refilling immediately after each backwash event. This causes the beads to float upward and reform as a bed. During the recharge cycle (a few hours), suspended solids in the trapped backwash waters settle into the sludge storage chamber for later disposal via the sludge drain valve (usually every 3 days- 1 week). At the same time, the clarified backwash waters are passed slowly through the bead bed again eliminating any backwash water losses.

The elimination of water loss associated with backwashing is a key element in this new technology. In most applications, dozens of backwash sequences can be automatically executed before sludge removal is required. There is no water loss associated with the backwash process and the water loss associated with sludge drainage is negligible. This strategy is particularly advantageous for marine systems, where the loss of saltwater must be minimized.

The pneumatic strategy breaks the linkage between backwash frequency and water loss and allows the nitrification capacity of the unit to be fully utilized. Frequent backwash sequences have proven advantageous for optimizing the nitrification capacity of the unit. Numerous gentle scrubbing cycles promote high rates of nitrification by maintaining a healthy thin biofilm on the bead surfaces. Typical backwash cycles occur once every three to six hours. In recirculating bioclarifier applications, where the High Pressure *PolyGeyser*® Bead Filter operates concurrently as a clarifier and biofilter, total ammonia nitrogen (TAN) levels below 0.3, 0.5 and 1.0 mg-N/l can be expected at feed loading rates of 0.5, 1.0 and 1.5 pounds feed per cubic foot of EN bead media (8, 16 and 24 kg-feed m⁻³ day⁻¹), respectively.

Table 5. High Pressure *PolyGeyser*® Bead Filter Specifications

Model	Assembled Height in/[m]	Diameter in/[m]	Media Volume ft ³ /[m ³]	Max. Flow Rate gpm/[lpm]	Max. Pressure PSI /[bar]	Charge Volume ft ³ /[L]	Inlet / Outlet Ports inches
HPPG-10	91/[2.31]	38/[0.96]	10/[.28]	150/[568]	10/[0.69]	10/[.28]	4/4
HPPG-15	110/[2.79]	38/[0.96]	15/[0.42]	225/[852]	10/[0.69]	15/[0.42]	4 / 4
HPPG-20	88/[2.24]	54/[1.37]	20/[0.57]	300/[1136]	10/[0.69]	20/[0.57]	6 / 6
HPPG-35	106/[2.69]	66/[1.68]	35/[0.99]	525/[1987]	10/[0.69]	35/[0.99]	6 /6
HPPG-50	120/[3.05]	72/[1.83]	50/[1.42]	750/[2839]	10/[0.69]	50/[1.42]	8/8

Backwash Operation Overview

The PolyGeyser filter is a breakthrough in filter technology. It features an advanced auto-pneumatic backwash mechanism. Water enters below the bed of enhanced nitrification media and travels upward through the filtration chamber where mechanical and biological filtration take place. Simultaneously, air is introduced into the charge chamber at a constant predetermined rate to achieve the desired backwash frequency.

Once the charge chamber has reached capacity, the pneumatic trigger fires. This releases the entrained air from the charge chamber below the bead bed. The sudden release of air from the charge chamber causes the beads to mix as the air agitates the beads. As the beads drop, the bead bed expands downward while water rushes downward through the expanded beads, sweeping the solids away and into the air charge chamber.

In the chamber, the solids settle out from the backwash waters and are later removed from the filter. Essentially, this type of filter recycles the backwash water while concentrating the waste products so that you have extremely low water loss while maximizing the nitrification capacity.

Frequent backwashing has proven advantageous for optimizing the nitrification capacity of a Polygeyser® filters. Numerous gentle scrubbing cycles promotes a higher rate of nitrification by maintaining a healthy thin biofilm on the surface of the bead media. Typical backwash cycles occur every 3-6 hours.

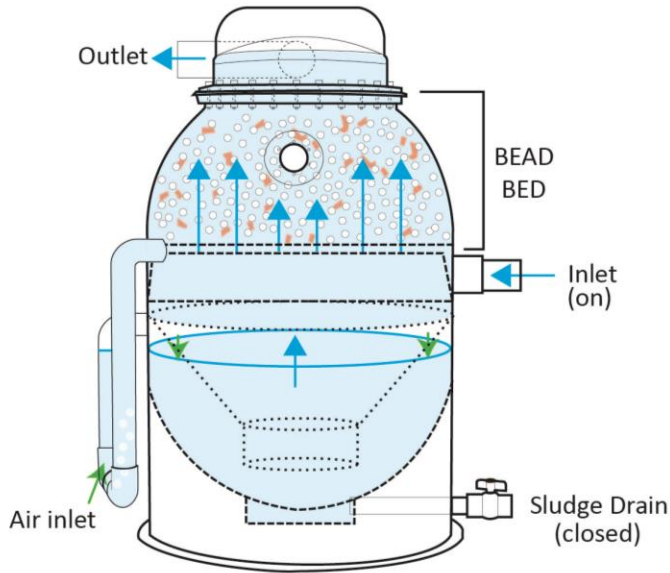

Normal Filtration

During the filtration mode, water continually enters the filter beneath the bed then passes through the bed where the solids are captured. Biofilms develop on the bead surfaces.

Meanwhile, air is slowly injected into the charge chamber. The bottom half of the HPPG filter, builds a charge for a backwash event and then functions as a settling basin, recycling of the backwash water.

The increase in air pressure pushes the water downward through the charge chamber then up through the center conduit of the cone. This is a very slow process; the solids swept into the charge chamber during the last backwash settle out. The clear water is then pushed back through the bead bed as it re-enters the recirculating loop

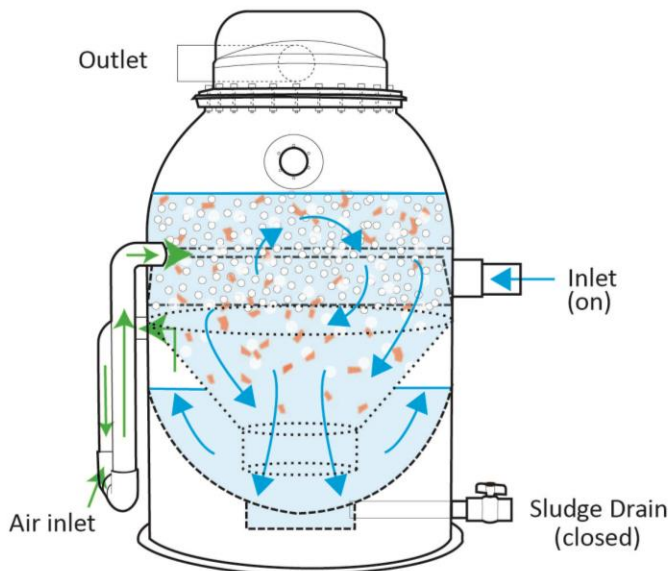
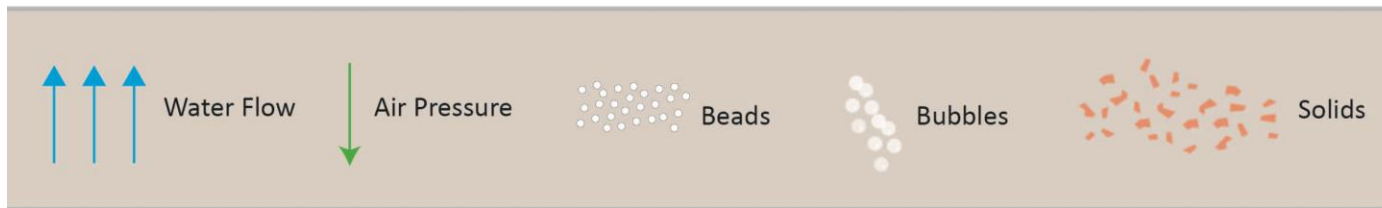

Early Backwash

No air escapes the air chamber until it is filled; then the air is suddenly released through the trigger mechanism. The bubbles exit the trigger just beneath the bead bed. The bubbles agitate the beads; knocking solids and biofilm off the beads. Water continues to flow into the unit, but no water flows out of the filter during the short three to five second backwash event.

As the beads are washed, the entire bead bed drops as the dirty water underneath is drawn into the charge chamber, replacing the air that is escaping through the trigger. Solids that settled into the sludge compartment are briefly resuspended and aerated.

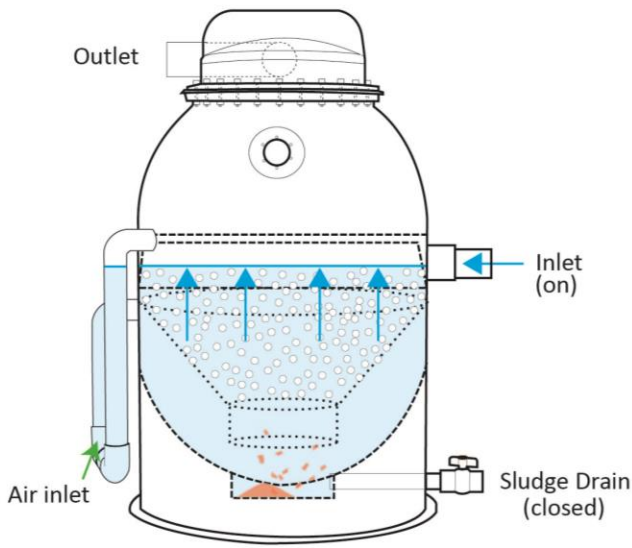

End Backwash

Eventually, the water rising in the sludge chamber floods the trigger, bringing water movement in the charge chamber and sludge basin to an end.

Solids begin to continue to settle as the filtration chamber is refilled with the water from the inlet. The beads float up to reform the bead bed. As soon as the water rises to the outlet, filtration resumes.

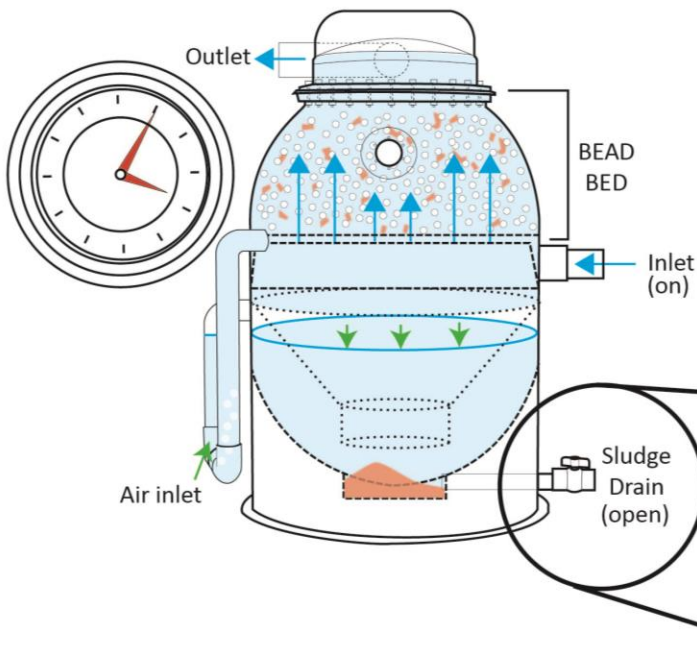
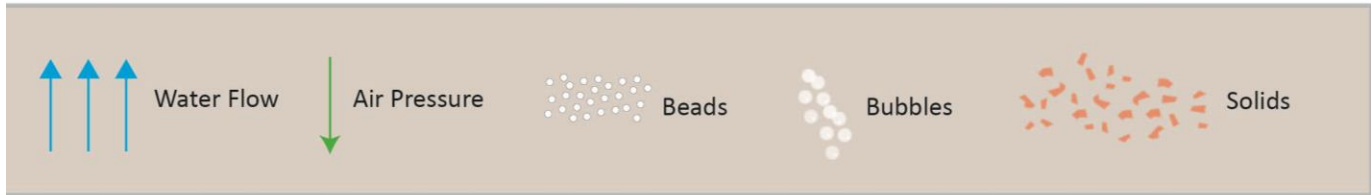

Periodically Drain Sludge

The filter will continue to filter and backwash itself several times a day. After the sludge has built up, the user can open the sludge valve to drain the concentrated sludge from the filter. A natural fertilizer, the sludge can be poured out on the lawn or nearby plant where it will naturally degrade.

HPPG Bead Filter Major Components

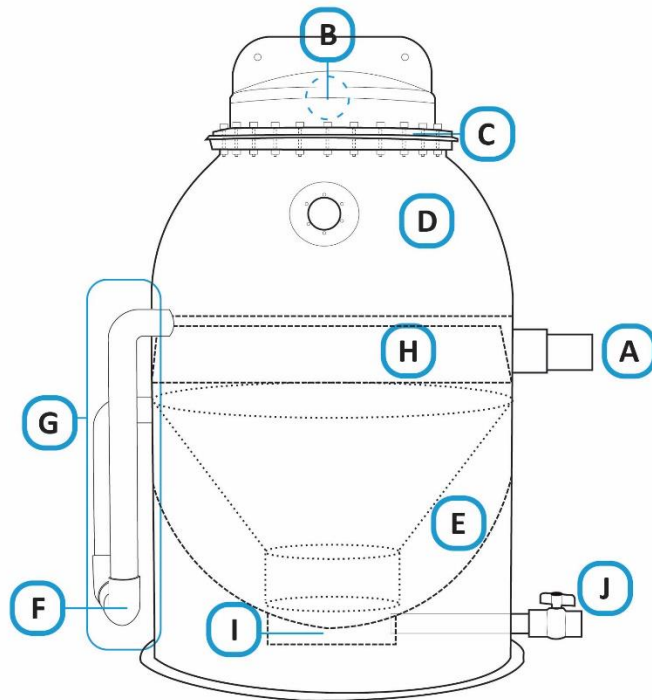

HIGH PRESSURE POLYGEYSER® HPPG FILTERS

A	Water Inlet Distribution Assembly
B	Water Outlet Distribution Assembly
C	Bead Retention Screen
D	Filtration Chamber Housing
E	Charge Chamber Housing
F	Air Inlet Assembly
G	Trigger
H	Water Diffuser
I	Sludge Storage Zone
J	Sludge Drain Assembly

Table 6. Major Component List – Basic Configuration

	Descriptor	Function	Comment
A	Inlet	Directs flow into filter via the diffuser	
B	Screen	Passes water while retaining the beads in the filter	
C	Outlet	Directs the filtered water into the return lines.	Multiple outlets are generally used for airlift models to lower water velocity and hydraulic friction
D	Bead Bed	Captures suspended solids while providing surface area for biological processes, such as nitrification, used to restore water to a pristine condition	The beads float to form tightly packed granular bed ideal for physical and biological filtration. Beads are typically 2-3 mm in diameter.

E	Charge Chamber	The air tight cone defines the charge chamber while forming a conduit for water transmission into and out of the charge chamber	In this design series, the charge chamber is wrapped around the centralized conduit which re-suspends and aerates sludge during each backwash event
F	Air Inlet	Slowly fills the charge chamber with air	Air is added at a slow rate so that it takes a few hours to fill the charge chamber .
G	Trigger	Catastrophically releases air from the charge chamber once it is filled	
H	Diffuser	Redirects the incoming water beneath the bead bed.	Hydraulically designed to minimize turbulence that may erode the bed.
I	Sludge Basin	Provides for temporary sludge storage.	The sludge that is released from the bead bed during a backwash settles out of the cone and charge chamber that can be removed periodically as a thick sludge through the sludge outlet .
J	Sludge Outlet	Facilitates the removal for thickened sludge from the unit.	Sludge is typically concentrated to 10,000-20,000 mg/L in the HPPG series.
	Cap	Directs flow from the screen to the Outlet pipe(s)	The cap assembly also includes gaskets that seal the screen to the filter hull .

Installation

Installation will require that you hook up a water pump to circulate water through the filtration bed and an air compressor to fill the charge chamber for the back wash sequence. Filters in the HPPG series are most frequently paired with a low head centrifugal pump capable of delivering a high rate of flow at relatively low pressures (5-10 psi). However, in commercial scale recirculating aquaculture applications, the units can be paired with airlifts to minimize energy consumption. Use of airlifts, however, generally requires lowering (burying) the unit so water can be filtered by gravity and then airlifted back up. With total filtration head losses beneath 0.5 psi, use of airlifts can be attractive whenever the physical configuration permits.

The backwashing air source must be matched with the circulation method you select. Simply stated the air pressure must exceed the water pressure for air to flow into the unit.

Pump Configuration

A self-siphoning, above ground, centrifugal water pump can be used to circulate water through an HPPG. The unit should have a water delivery capacity of 10-15 gallons per minute for each cubic foot of

media at the operational pressure for the unit (typically in the range of 5-15 PSI). **The shutoff pressure off the pump should be less than 20 psi, or near 20 psi when a pressure relief is installed to avoid damaging the HPPG hull.**

HIGH PRESSURE POLYGEYSER®
HPPG FILTER EXTERNAL PLUMBING

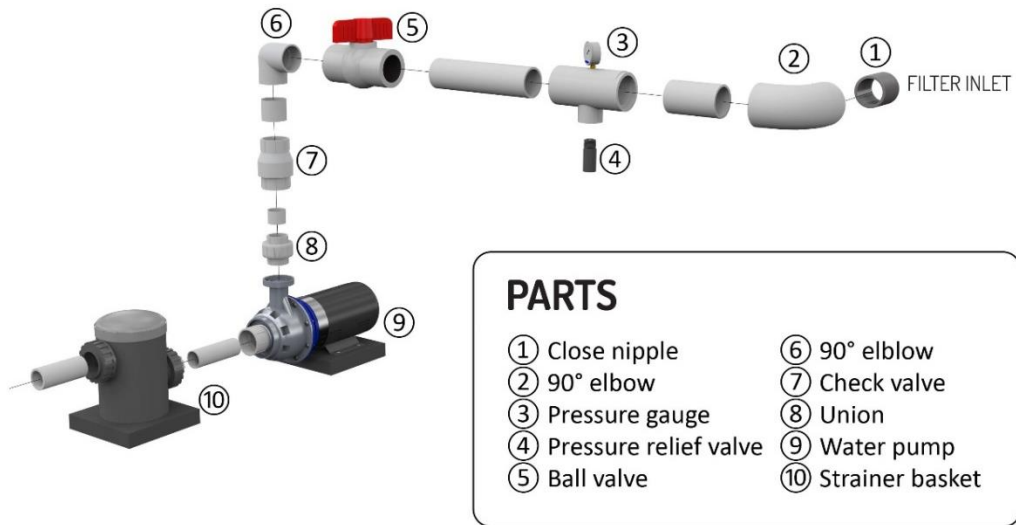

HPPG Filter External Plumbing illustrates a typical plumbing arrangement. In most case the pump (9) should be protected by a screen or an inline screen basket (10). Many pumps already have the inline basket attached. A hard PVC couple (8) is placed immediately adjacent to the pump discharge to facilitate pump replacement or servicing. A rubber or flexible couple should be avoided here, as they are sensitive to pump vibration tend to work loose. **This coupling is followed immediately by a mandatory check valve (7) which prevents the backflow of beads into the pump during periods of power interruption.** If the pump’s flow capacity is significantly greater than the filters rating then a ball valve (5) is then placed in line to allow the pump to be throttled to manage flow through the HPPG unit. Alternately a “tee” can be placed at this location with two ball valves allowing for flow to bypass the unit to a parallel use. You will find a 0-30 psi pressure gauge (3) will greatly facilitate the management of the filter. High pressures are an indication to increase the backwash frequency. **Finally, in situations where either the water pump or the backwashing air pump have high shutoff pressures (>20 psi) then a pressure relief valve must be placed immediately adjacent to the filter input to assure protection of the hull.** The pressure relief valve can be set to pop at 20 psi. All HPPG filters are pressure tested at a higher pressure to ensure quality prior to shipping, but the operational pressures should not exceed 20 psi.

Airlift Configuration

The HPPG series is equipped with an oversized screen and inlet/outlet plumbing to facilitate airlift operation. Typically, the filter must be positioned next to the tank so that the screen is 12-15" below the water level in the tank. The siphoning outlet pipes are then directed toward the ground to develop pressure for the airlift operation. The discharge pipes are then curve back to the vertical draft tube. Air is injected near the bottom of the draft tube to create a low density air/water mixture that is pushed upward by the dense water in the siphon line. The elevated air and water mixture is then moved horizontally to the tank.

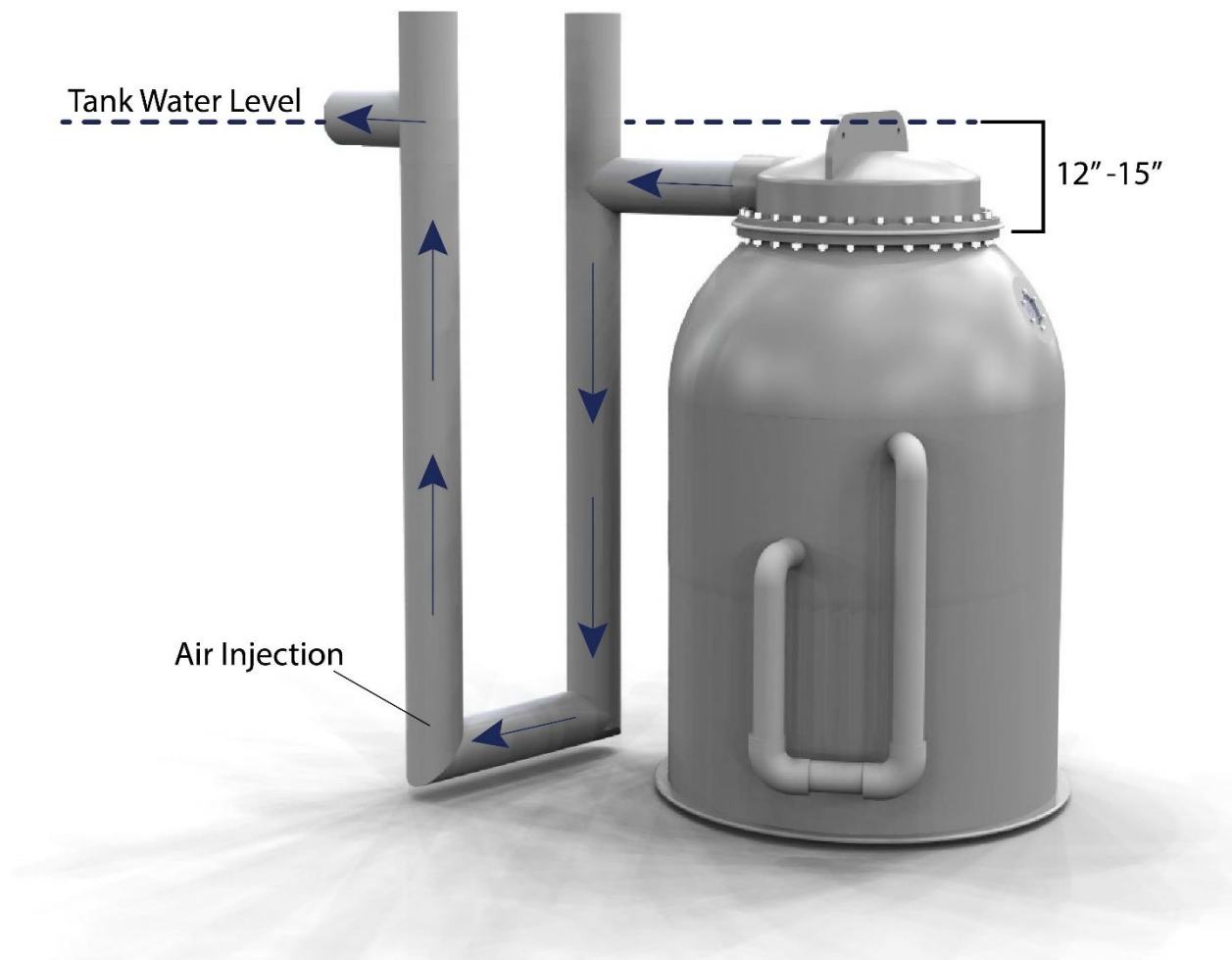

Water Flow in an Airlifted HPPG: Water exits from the top of the filter, into the U pipe. Air injected into the far draft tube pushes the water up and out of the pipe, back into the tank.

Air Flowrate Calculations for Airlift Configuration

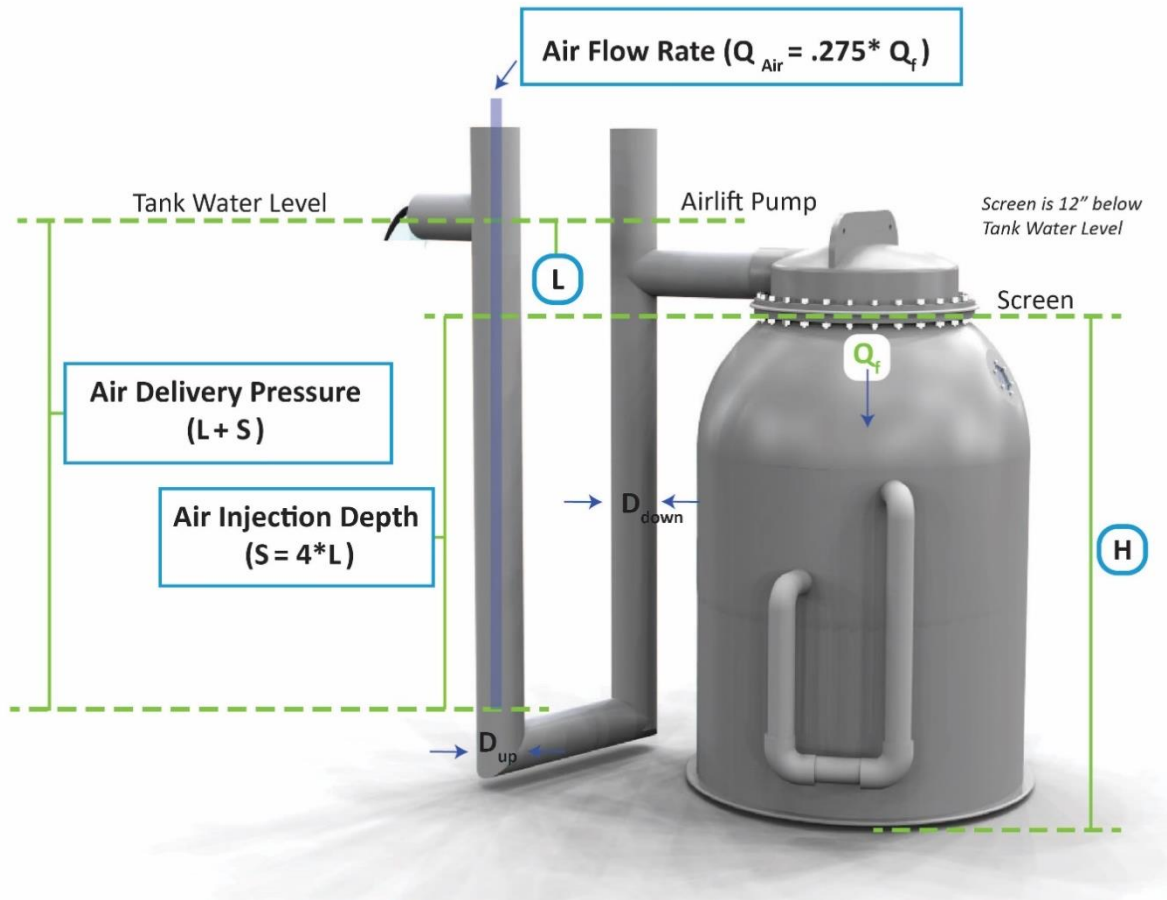

Table 8. Air Flowrate Calculations

Model	Flowrate (Q_f , gpm)	Outlet Pipe Size (in)		Flow Velocity (ft/s)		Screen Level (in) (H)	Air Lift Requirement (in) (L)	Air Injection Depth (in) (S)	Air Delivery Pressure (in) (L+S)	Air Flowrate (Q_{air} , scfm)
		(D_{down})	(D_{lift})	(V_{in})	(V_{lift})					
HPPG-10	150	4	6	3.84	1.69	83	12	48	60	41
HPPG-15	225	4	8	6.40	1.63	102	12	48	60	62
HPPG-20	300	6	8	3.37	1.94	80	12	48	60	83
HPPG-35	525	6	6	5.62	1.53	97	12	48	60	144
HPPG-50	750	8	12	4.86	2.17	111	12	48e	60	206

Backwash Air Pump

Backwash air pumps are required to operate an HPPG filter. If you have not purchased a backwash pump with your HPPG filter, you require a low volume continuous duty pumps that is sized to sustain the appropriate backwash frequency for your filter model. The pump must also be compatible with the pressure range that is appropriate to the filter. Noise will be generated by the pump, so placement should be carefully considered. If the pump is placed outside or in a wet room, it should be properly insulated from water and condensation.

The operational pressure for air injection into the charge chamber of a water pump driven HPPG filter with a free discharge out of the outlet pipe should be in in the range of 4-6 psi if the backwash frequency is set properly. At design flow rates about half of this pressure is attributed to the physical depth of the air injection, the balance is attributed to baseline friction loss through the bead bed or fittings. If the backflush frequency is set too low, the pressure loss across the bead bed will increase. In the extreme, the hull pressure will be defined by the shutoff pressure of the pump. The air pump should be sized to overcome this pump shutoff pressure. Ideally, the air pump and water pumped should be matched with the air pump having a shut off pressure higher than the pump.

Injection pressures for HPPG airlift applications are controlled by the distance from the tank water surface to the centerline of the horizontal pipe in the unit's external trigger (typically a maximum of about 100 inches or 4 psi). The air injection pressure in an airlifted HPPG does not vary much. An operational pressure of 5 psi is sufficient.

A medium sized linear air pump is a good choice for airlift applications where backpressures on the HPPG unit are minimized. These units operate by oscillating a rubber diaphragm that moves air through a series of valves. These pumps are readily available in weather resistant configurations used for pond and home packed wastewater treatment units. The flow rates delivered by these blowers are generally in excess of the backwashing needs, so the unit should be selected based upon its maximum operational pressure. The larger liner pumps have shutoff pressures in the range of 10 psi which is suitable for most HPPGs where the unit is not back pressured by downstream devices. Linear air pumps contain a replaceable rubber diaphragm that will ultimately fail (every 2-3 years depending on the model and pressure).

A small oil free continuous duty piston pump with an operational pressure rating of about 20 psi is most ideally suited for delivering air for a wide variety of HPPG applications. These units have small pistons that are driven directly by a small electric motor. Producing only moderate amount of air, these unit are recognized for sustained operation at the moderate pressures demanded by HPPG applications. Capable of delivering a continuous supply of air at the HPPG maximum hull pressure of 20 psi, these units also display relatively high shutoff pressures that are compatible with a wide variety of pumps. The air volume produced by this unit is reduced and thus the air delivery capacity should be matched to the HPPG. These units are most often sized to serve the air demands of a single HPPG unit.

Rotary vane compressors operate in a pressure range (0-15 PSI) well above the more widely recognized rotary vane blower (0-3 psi). A rotary vane compressor consists of a motor that spins a set of inclined

high speeds blades that compress and accelerate air into the distribution system. They are capable of producing large volumes of air in the 10 psi range. These units are typically the air supply of choice for facilities containing multiple High Pressure PolyGeysers® filters.

The common oil-less shop compressors can be used to backwash a HPPG unit. Commonly capable of producing pressures in excess of 100 psi, these units are capable of overcoming any pressure produced by a water pump. These units are powerful piston units that produce a relatively small volume of air at extremely high pressures. Normally installed with the delivery pressure regulated down to 20 psi, these compressors can be set to match virtually any water pump. Inexpensive shop compressors are not designed for continuous duty. A compressor tank is usually associated with the compressor unit and the motor operates intermittently to maintain the tank pressure. These units should be sized with a delivery capacity 5-10 times higher than the backwashing air capacity to assure the compressor operates only periodically. (Note: These compressors are typically rated in terms of cubic feet per minute at 100+ psi whereas backwash demands are rated in cubic foot per hour at 20 psi). Shop compressors are generally noisy and are poorly designed for a wet environment. Under normal circumstances, the air pressure delivered to a unit does not influence the pressure experienced by a HPPG hull. Air input into the unit merely displaces water; there is no potential for internally damaging the unit by over pressuring the charge chamber. However, the pressures generated by a poorly adjusted shop compressor (i.e. the discharge pressure regulator is set too high) are clearly capable of catastrophically cracking hull rated for 20 psi. This can occur if the unit is “dead headed” by closure of an outlet line trapping the pressure between an inlet check valve and the closed outlet valve. **Thus, units employing shop compressors for backwashing must be equipped with a pressure relief valve on the air line or a water line immediately adjacent to the hull on the influent or effluent side.**

Pump	Typical Pressure Range	Comments
Linear Air	0-10 psi	Excellent for backwashing of filters that are not back pressured by downstream constrictions, may be over powered by shutoff head of water pump so should be protected by check valve. Energy efficient.
Piston	0-30 psi	Generally suitable for all HPPG applications. Capable of generating pressures in excess of hull pressures thus cannot be overcome by properly sized water pump.
Rotary vane compressor	0-15 psi	Suitable for low pressure airlift applications and simplified pumped configurations. Produce volumes sufficient to
Shop	0-150 psi	Oil free shop (piston) compressors with tank work well as a backwash air supply provided they are sized large enough to provide for extended cycle time. Tend to be noisy and over pressurized, but, inexpensive.

General Setup Directions

1. Prepare your filter's location. The High Pressure Polygeyser® must be installed on a level surface to backwash properly. The unit is designed to tolerate only about ½ inch of vertical displacement edge to edge across its width in any direction. Failure to properly level the may cause the unit to prematurely backwash (i.e. before the charge chamber is filled) or fail to backwash as the air in the charge chamber bypasses up the center of the cone.

If using an airlifted configuration, the screen should sit 12-15 inches below the source tank water level. If this requires placement of the HPPG hull partially below ground, buoyancy calculations should be undertaken. High ground water conditions or simple flooding of the unit can generate buoyancy force of several thousand pounds. Maximum buoyancy occurs when an empty filter is flooded externally to the screen elevation. The units can be held down by a concrete collar placed around the upper dome. A fully buried unit, in the worst case, would require in excess of 2 cubic foot of concrete per cubic foot of beads in the filter.

2. Connect your inlet and outlet plumbing. See *pump or airlift configuration* for detailed plumbing directions for your choice of setup.
3. Attach your backwashing air pump. **Whenever a water pump is employed, the backwash air pump must be protected by a check valve that prevents backflow into the air delivery system.** Without the check valve, the air pump will be damaged the first time it is accidentally turned off or mechanically loses pressure.

In air lift applications, the backwash air pump may be protected by elevation only. Placement of the air a few feet vertical above the tank water level is sufficient to protect the pump.

4. Decide how to deal with drained sludge. You can place a bucket under the drain valve, or run a PVC line to wherever the sludge should drain. Sludge

can be used as fertilizer for plants. In aquacultural applications, sludge production is estimated at 3-6 gallons per cubic foot of beads per day at design capacity (1.5 lbs feed/ft³-day). Sludge handling should be sized for a generation rate of about 10 gallons per cubic foot of bead per day. See *sludge drainage assembly* for more details.

5. **Once your unit is plumbed, fill it, turn on the water pump. Set the backwash feed rate at the maximum to achieve the highest backwash rate attainable with your set up (possibly as much as once every 15 minutes). Let the unit operate in this manner for 12-24 hours, more if possible.**
Under normal operation the bead bed is formed by simple buoyancy. There is one screen in the head designed to constrain the beads. The unit's pneumatic and hydraulic behavior is designed to substantially confine the beads to filtration bed. During shipping, a substantial proportion of the beads fall into the charge chamber where they are trapped (by buoyancy) in the charge chamber. So when you first fill the HPPG, perhaps fifty percent your filtration bed is in the lower chamber. The unit's trigger is designed to pass beads from the lower chamber, but only at a hand full per cycle. So the system must be operated at a high backwash frequency for a time to readjust the unit's internal balance.
6. Adjust the backwash pump's air flow down after the first day, so that the filter backwashes two four to four times daily. Your application may benefit from adjusting the backwash frequency up or down depending on your loading.
7. Now look through the port hole that is positioned on the upper dome of the HPPG unit. This is what a clean bead looks like. These beads will become beige with nitrifying bacteria over time. If beads appear very brown or clumped, increase the backwash frequency.

Adjusting your Backwash Frequency

Your PolyGeyser[®] filter employs a static bed of beads to capture suspended solids and/or provide substrate for development of a biofilm to remove targeted dissolved pollutants (organics, ammonia). After time, the accumulation of solids in the bed begins to reduce the hydraulic conductivity of the bed

and the flow passed through the unit declines. Each application has its optimum interval for backwashing. In some cases, an extended backwash interval produces optimum performance and in others, and extremely short backwash interval is best. In broad terms, short backwash intervals (<6 hours) are associated with heavy loads. Best performance for lightly loaded applications is usually associated with extended backwash intervals (>12 hours).

In recirculating aquaculture or wastewater clarifier applications where the HPPG is used solely as solids capture device reducing suspended solids levels, a high backwash frequency generally produces the greatest mass removal rate. In these applications, the targeted particle size range is usually of the order of >50 microns. Organics in the water will create a sticky surface that tends to stick particles together on the bead surface. Internal settling after a backwash is rapid, and backflush frequencies can be short (<hour) without adversely filter performance. **A good starting point for the backwash interval in a recirculating clarifier application is 3 hours.** If a decline in flow through the filter (or an increase in hull pressure) is noticeable, increase the backwash pump airflow for more frequent backwashes.

If the application is focused on water clarity for display aquaria or zoo applications, then the HPPG should be used as a clarifier focusing on small suspended particles. A clean bed of standard sized beads has relatively poor single pass removal efficiency (20%) for particles below 20 microns. Single pass capture of these particles is dramatically improved (>40%) once the bed begins to fill with biological or mineral solids. Excessive backwashing should be avoided in clarifier applications. Lightly loaded HPPG applications with a focus on water clarity (reduced turbidity) are generally associated with extended backwash intervals, perhaps, twice a week. **In lightly loaded application seeking high water clarity, start with a backwash interval of once a day.** Increase the backwash frequency (turn up the air) if the flow through the filter declines significantly as this is a sign solids are not being backwashed enough for your application. For single pass applications, the best water clarity is always obtained with reduced flow and high pressure drop across the bead bed.

In recirculating applications, the benefits of increasing single pass efficiency by flow reduction are offset by the reduction of number of filtration passes. The optimum in a recirculating application is normally found at an interval that high pressure drop across the bed and high flows, a zone of moderate pressure loss across the bed.

Clarifier applications are relatively insensitive to backwash interval, HPPG biological function can be dramatically influenced by the backwash frequency. Here backwashing influences several factors (Table 6). Optimization of backwash frequency is application specific and your HPPG allowing process optimization under both aerobic and anaerobic conditions across a wide range of loadings and targeted substrates.

Table 6. Backwashing interval impacts biofiltration through several factors.

Factor	Importance	Comment
Biofilm thickness	Controls the mass of bacteria working	

	Controls the rate limiting nutrient transport into the biofilm	
Water flow	Controls the targeted substrate concentration adjacent to the bead Controls oxygen transport to the biofilm Controls turbulence at the biofilm water interface	Best biological treatment is associated with the highest achievable flows
Mean cell residence time (MCRT)	Determines the type of bacteria and protozoa that will be found in the filter.	

In recirculating aquaculture applications, PolyGeysers® are widely used as bioclarifiers simultaneously removing suspended solids, dissolved organics, total ammonia nitrogen (TAN) and nitrite nitrogen. Here the limiting process step is usually TAN conversion since the TAN must diffuse into the biofilm prior to conversion. Carbon to nitrogen ratios are relatively stable being fixed by the protein content range of the feed. Backwash frequencies must be increased with organic loading (pounds feed/cubic foot beads per day) to offset the smothering effect of heterotrophic bacteria on the slower growing nitrification bacteria. The general guideline for backflush frequencies is illustrated in Figure__.

In recirculating applications, the backwash tuning success is reflected in the TAN and Nitrite concentration. It is not uncommon to see the TAN concentration reduced by 50% with a small change in backwash frequency. The limits of backwash frequency are defined by the nitrite oxidizing bacteria (NOB). Backwash too often and the NOB are “washed out” as the biofilms mean cell resident time (MCRT) drop; Wash too slowly and oxygen transport into the biofilm will drop, triggering or reversing the NOB oxidation process. So watch for the telltale rise in nitrite as you optimize backwash frequencies.

In domestic wastewater treatment where biological oxygen demand (BOD₅) and Total Suspended Solids (TSS) are targeted, frequencies tend to be high (once every 3 hours) to maintain hydraulic conductivity of the bed. The backwash frequency for biological operation is largely controlled by the organic loading (kg-BOD₅/m³ of bead-day). Failure to backwash frequently enough leads to clogging of the bead bed as heterotrophic bacteria attack readily biodegradable organics.

Sludge Drainage Assembly

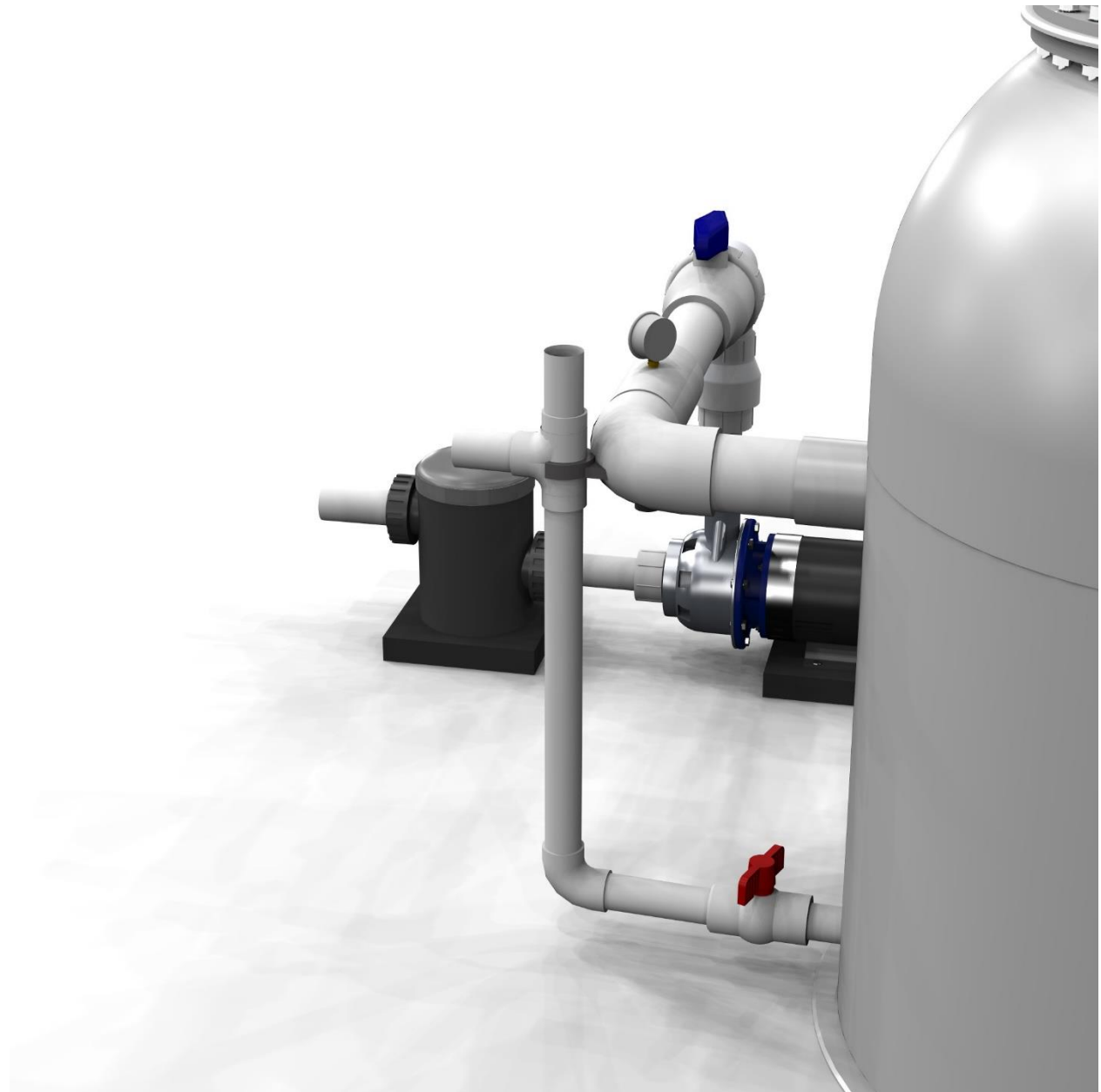

Sludge Drainage Assembly, recommended Plumbing: PVC pipe, 90° elbow, Tee. Ball Valve is included. Pipe clamp recommended.

Connect drain line to the installed bottom valve for sludge drainage. AST recommends that the sludge pipe connect to a 90° elbow, pointing up. The vertical pipe should come to a tee positioned on the midline of the inlet to prevent bead loss when draining the sludge. Make sure the sludge pipe is securely attached to avoid breakage.

Air Pump Requirements for Backwashing

The Charge Chamber capacities for *PolyGeyser*® Bead Filter Models HPPG-10, HPPG-20, HPPG-30, HPPG-40, and HPPG-50 have a fixed volume of air to charge the chamber. Once this volume is met, the trigger will fire and the filter will backwash.

In selecting an appropriate air pump for the system, the air flow capacity (scfh or lpm) required to effect backwashes at the desired intervals and air delivery pressure must be taken into consideration. If the filter is operated with a water circulation pump, the air delivery pressure must exceed that of the water pump to prevent ***accidental flooding of the air pump, which may present an electrical hazard.***

Additionally, a check valve should be installed in the air line to prevent flooding of the air pump in the event of a power outage and to protect the air pump in case of excessive pressure development in the filter.

We recommend using an air pump capable of producing the most frequent backwash intervals that may be required. The flow rate can then be regulated by installing an air flow meter, with a built-in regulating valve. AST offers an air flow meter kits which includes an Acrylic Air Flowmeter, a Labcock Valve, a Pressure Gauge, a Nylon Spacer and Fasteners, Barb Fittings and other PVC Fittings. This is strongly recommended for air pumps that do not have built-in air adjustment on them. Adjusting the air flow directly impacts the frequency of the filter backwash.

Selection of proper backwash air pumps is of less concern when operating in the airlift mode, since the system operates at a very low head (36-48" / 92-120 TDH). Several commercially available air pumps are capable of delivering the required volume and meeting the pressure demands for a single unit. However, the selection of air pumps is ultimately dependent on the selection of water pumps.

Backwash Frequency

Figure A presents the relationship between air delivery to the charge chamber and backwash frequency for the various HPPG models. These air flow rates are listed in cfm at the pressure of delivery as they would appear on a rotameter connected to the model. Air is compressible. The volume of air required to initiate a backwash in an HPPG is fixed by its design, but, the exact backwash interval produced can be influenced by pressure patterns on the hull. If the hull pressure rises significantly during the filtration interval, then the actual backwash interval will longer (by a few minutes) than the table indicates.

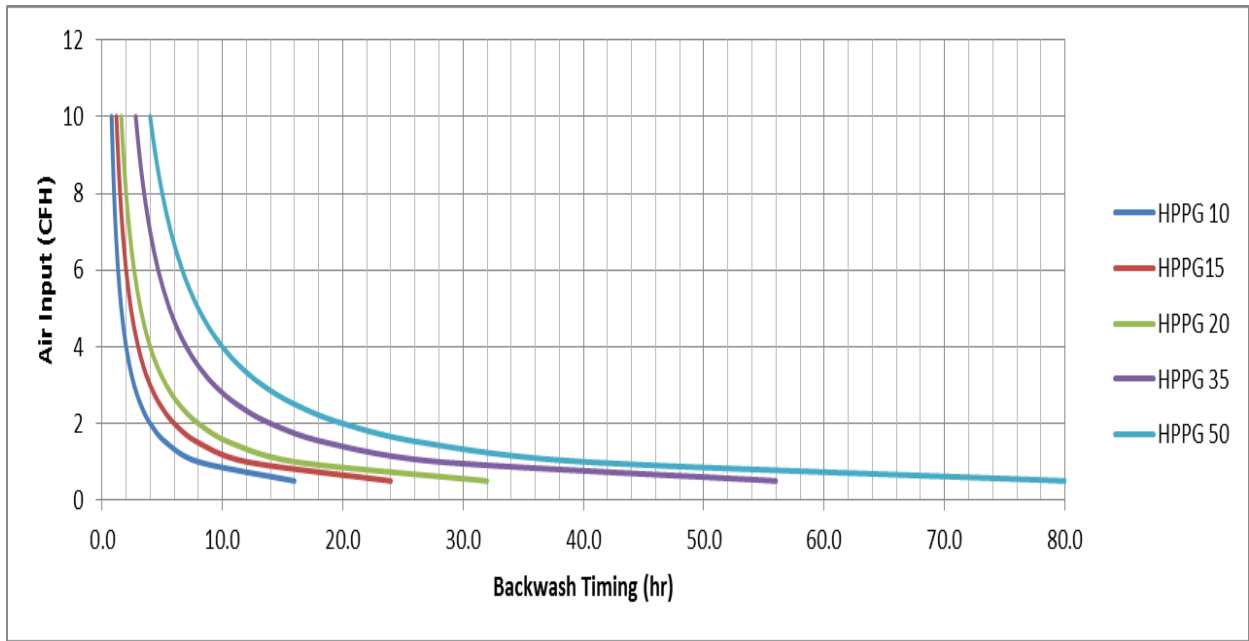
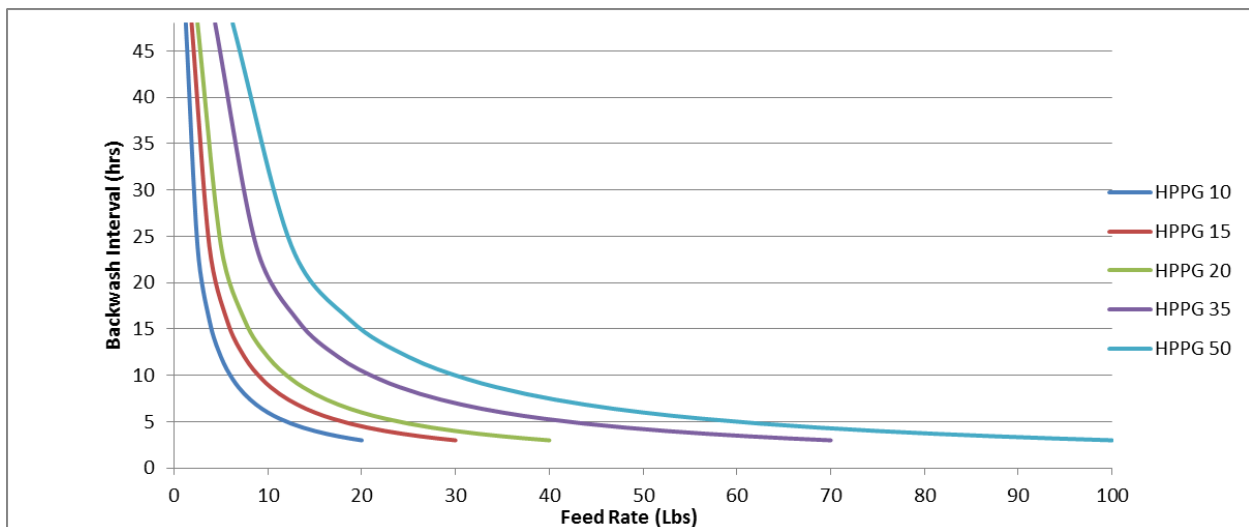

Figure A : Air input rate required to obtain a targeted backwash interval for the HPPG series can be estimated from this graph. Flowrates are given at operating pressure as would be shown on an attached rotameter.

The optimum frequency of backwash intervals varies with feed loading. Figure B below presents recommended backwash regimes and associated air flowrates for targeted feed rates. These recommended intervals should be considered starting points as true “optimums” are defined by temperature, feed compositions, and recirculation rates. Under light loading conditions (<0.5 lbs feed/ft³ beads-day) you will find the HPPG provide excellent water quality across a broad spectrum of backwash frequencies. Under heavily loadings (>1.5 lbs feed/ft³ beads-day) the rate of biofilm abrasion must be balanced with rate of biofilm growth more precisely. Small changes in the backwash interval can results in dramatic drops in TAN or nitrite.



Troubleshooting (Filter Function)

This troubleshooting guide is based upon the feedback received from actual PolyGeyser® users. The most common solution to the issue is listed first. The PolyGeyser® line is generally a very trouble free unit. If you are having trouble, call your supplier for help. Other than beads, there are no moving parts in a HPPG unit. The problem can be usually deduced by observation. This first section of the Troubleshooting guide is focused on operational issues associated with the filter.

Dirty water comes out of my filter after a backwash

Your HPPG was specifically designed to minimize this issue.

1. You are manually activating the backwash. The HPPG unit was designed with the presumption that backwash intervals would be short. Automate the unit and increase the backflush frequency,
2. You have the unit on an extended backwash interval, increase the backwash frequency. Keep the bed clean of debris.
3. If your unit takes more than 5 seconds for air discharge, your trigger is blocked or partially blocked. You have a dysfunctional trigger and the unit is not dropping properly. See the section on the air “burps”.
4. If your unit washes quickly (<5 seconds) but fails to drop (look through the port hole) you may be flooding the filter with excessive flow during the wash. Check if your water pump sized properly for the HPPG model.

The flow coming out of my HHPG is dramatically reduced.

Check your pressure gauge on the pump side of the filter. If it low, you have a water pump issue. If it is high, you have a backwash problem.

1. If your pump pressure is normal or high then you have an air delivery problem and the bed is clogging.
 - a. Check the rotary meter for the air. If the ball is down, open up the rotary meter and increase air flow to the charge chamber.
 - i. Ball will not come up. Your air pump cannot overcome the hull pressure established by the water pump. This is most commonly seen with linear air pumps.
 1. You may have just set your backwash interval too low and now you are trying to push against the shutoff pressure of the water pump.
 - a. Turn off the water pump and increase the backwash frequency. Let the unit dry wash for several cycles then

turn the pump back on and set your backwash frequency higher.

- i. Put a pressure relief valve on the intake side of the filter and set it below the shutoff pressure of your air pump.
 - ii. Buy an air compressor with a shut off pressure higher than your water pump.
 - b. Inspect the line between the rotary meter and the HHPG unit. Is there a kink or has something pinched the line off?
 - c. The diaphragm in my linear air pump is developing a crack.
 - i. Replace the diaphragm. At high pressures the diaphragm in a linear air pump will fail in a year or two.
 2. The ball comes up. Problem over, or...
 - a. Check the line between the rotameter and the HHPG unit. Has the line slipped or is there an air leak where the line is connected to the HPPG unit?
 - b. Has the external hull been damaged? Is there any evidence of a water leak on the bottom half of the unit?
2. If your pump pressure is low:
- a. Check to see if the intake screen is clogged. If so, clean the inlet screen out. Pressure should restore immediately.
 - b. If you have an inline screen with a clear top look for bubbles in the screen compartment. IF there are a lot of bubbles present, the air may be breaking the centrifugal action of the pump.
 - i. Is there an air stone or packed column discharging air bubbles where they can be drawn in to the pump?
 - ii. Check the seals on all threaded PVC pipe fittings on the suction side of the pump. Turn off the pump and let the filter backpressure the line. A small water leak will indicate a large air leak.
 - iii. Check the very end of the inlet line for a vortex. Is water spinning and sucking air? Raise the water level or break the vortex.
 - c. IF you don't have an inlet screen protecting the pump: Remove the propeller housing from you pump and check for debris in the centrifugal chamber. You will find it typically jammed across the outlet port.
 - d. Remove the propeller housing on your pump and check the impeller for a broken blade or a loose set screw.

The unit continually “burps” air through the bedunit never backwashes

Air passing through the bead bed during the filtration stage or just prior to backwashing indicates a backwashing issue.

1. The trigger is clogged. This condition occurs most often when a unit is just set up or subject to heavy organic loading. Basically a clump of beads has jammed in the trigger preventing air release.
 - a. Try tapping the trigger on the inlet end (the low end) with a rubber mallet. This will normally vibrate the clump free.
 - b. Try tapping the trigger on the discharge end (the high end) with a rubber mallet, the clog may be at this end.
 - c. Try draining the filter about half way while the chamber is still filled with air. This will increase the pressure differential and allow the clump of beads to be pushed out.
 - d. Remove the trigger and inspect for obstruction.
2. The charge chamber is leaking (the filter has been recently transported):. Turn off the air supply to the charge chamber. If the bubbles continue, then you may have a leak. Pull the filtration head and screen. Remove the beads. Fill the unit with water until the trigger outlet is covered by about 12 inches of water. Fill the charge chamber and inspect for leaking bubbles.

The unit “burps” air through the bed before it backwashes.

Delays in trigger firing are sometimes evidenced by a slow release of air through the trigger or under the HPPG cone. These delays undermined the backwashing strategy and should be corrected.

1. If you are accelerating the wash sequence by dramatically increasing the rate of air input then reduce the rate of input. It takes several seconds for a trigger to respond to a change in air level in the charge chamber. This causes a lag time between filling the chamber and trigger release. If you put the air in too fast then the chamber will overflow air before the trigger can react.
2. Your trigger could be loosely clogged. The clog produces a backpressure on the charge chamber, but slowly releases air. The air passing through the trigger clog, however, erodes the clog and the unit then backflushes after a few seconds. Try increasing the backflush frequency. This will loosen up the beads, knocking off excessive biofilm that is sinking them and cause them to move into the charge chamber where they cause problems. A partially clogged trigger can lead to a visible discharge of dirty water.
3. The discharge end of your trigger maybe embedded in the bead bed. Beads cannot escape for the trigger and a transitional stream of bubbles results. You have too many beads in the unit or the bed is eroding and piling beads on top of the trigger. Try reducing the water flow to the unit.
4. Unit maybe poorly leveled. If the unit is poorly leveled then some air may release just moments before the trigger. Normally is seen only when a marginally leveled

unit is coupled with a low backwash interval. Try leveling the unit by raising the side opposite the trigger.

5. The trigger may be set to low (is this a new filter?). Try raising the unit on the trigger side and test firing. Call AST; highly unlikely, as all units are test fired before shipping.

The Beads Seem to Be Fluidizing

1. The *PolyGeyser*[®] Bead Filter Models HPPG-10, HPPG-20, HPPG-30, HPPG-40, and HPPG-50 are designed with specific peak flow rates. If you exceed this flow rate, you can cause the beads to fluidize. When beads are fluidizing, they do not capture solids. To correct this problem, simply reduce the flow through the filter.
2. Or, the inlet diffuser might be broken or be rotated out of the proper vertical position. Lower the bead bed by draining and check to see if the top of the inlet diffuser opens vertically. The diffuser should be securely anchored to the sidewall on both ends. If not call or email AST for assistance.

The sludge coming out of my HPPG stinks like rotten eggs.

This is part of the price paid for water conservation. Organically rich sludge decaying in the absence of oxygen will smell like rotten eggs as sulfur is reduced. This is a transitional problem. Once the sludge is exposed to oxygen, the smell will disappear.

1. Try increasing your backflush frequency.
2. Discharge your sludge through a hose that will prevent exposure to the air.
3. Take sludge out of you HPPG more often.

Trouble Shooting for Recirculating Aquaculture Applications

Very high nitrite levels

A system characterized by high nitrite levels is normally associated with system acclimation or is suffering from a low pH or low oxygen levels.

If the system is newly set up then be patient, the establishment of a strong population of nitrite oxidizing bacteria can be a slow process particularly with saltwater or cool temperatures. The only way to practically accelerate the process is to heat the water.

Poor Water clarity

Recirculating systems filtered with an HPPG should be characterized by relatively clear water. If the water in the tank appears opaque or cloudy then you may have an issue with the performance of the HPPG unit.

1. You may have air bubbles in your recirculating flow. These bubbles are moving up through the bed dislodging fine solids. Check the suction side of the pump for air leaks.
2. Try decreasing your backflush frequency. This will increase your internal settling time between backwash events and improve the fine solids capture of the bead bed.

Low pH

The pH in an RAS will naturally decline as nitrifiers convert TAN to nitrite. Bicarbonates are gradually consumed by the nitrifiers and both the fish and bacteria excrete carbon dioxide that tends to lower pH. If your pH is below 7.0, increasing alkalinity is warranted immediately to prevent TAN or nitrite accumulations.

- If the alkalinity is below 100 mg-CaCO₃, add sodium bicarbonate or soda ash until alkalinity exceeds 150 mg-CaCO₃.
- Increase aeration to the system. This should lower the carbon dioxide and raise the pH.

Elevated Ammonia Levels

- Elevated levels of Nitrite may occur if the dissolved oxygen concentration in the effluent leaving the filter drops below 2 mg/l. Low DO concentrations leaving the filter can often be solved by increasing the dissolved oxygen levels in the tank/pond or through increased aeration or by increasing the flow rate through the filter.
- Elevated Nitrite levels may also occur if your total alkalinity (as CaCO₃) drops below 80mg/l. We recommended you maintain your alkalinity at 100-200 mg/l as CaCO₃ at all times. If you experience low alkalinity, simply add baking soda to the filtration system periodically to maintain proper levels. Sodium bicarbonate is not suitable for aquaponics applications because sodium can harm plant development and growth. Applications of different liming agents, such as potassium hydroxide (KOH) and Ca(OH)₂ are recommended for balanced plant growth.
- Elevated Nitrite levels can also occur from over washing the bead bed. If the flow rate, effluent oxygen and alkalinity are satisfactory, the backwash frequency can simply be reduced. This situation typically occurs when you go from periods of high loading and frequent backwashing to periods of reduced loading with frequent backwashing.
- Although generally the nitrification can be achieved across a wide ban of backwash intervals, backwashing for cold water systems must be more carefully managed. Generally, backwashing should be limited to a low frequency (<1 day) for cold water applications. The reduced frequency allows more time for the slow growing NOBs to recover from backwashing biofilm damage.

Sulfide Production

Sulfur is normally found in a surface water in the form of sulfates (SO₄²⁻) an inert compound that has little impact on aquatic species. If the oxygen is removed from the water, then the sulfates are

converted to sulfites (SO_2^-) or sulfides (S^-) which are toxic to many aquatic species. The smell of sulfides is likened with the smell of rotten eggs.

After a backwash, the particles released from the bead bed are settled into the sludge compartment where they immediately begin to decay. The decay process depletes the oxygen and the sulfates found in the sludge are converted to sulfides. If the sludge accumulates for several days, you can smell the sulfides as the sludge comes out of the sludge discharge pipe. This smell disappears as soon as the oxygen re-enters the sludge. If the sludge is applied to land, the smell will almost immediately disappear. If the sludge is placed in a tank, it will continue to smell until the tank is aerated.

Your *PolyGeysers*[®] is designed to mitigate any sulfites or sulfides that are produced under normal operations. The unit is designed to re-suspend the sludge each backwash cycle which introduces oxygen back into the sludge. The rate of sulfide release from compacted sludge is very slow. The amount of sludge in the internal sludge storage has minimal impact on sulfide release. Any released sulfide is diluted and aerated as it moves upwards from the sludge basin through the filter. By the time sulfides reach the bead bed they have reacted with oxygen and converted back to sulfate (safe).

There are no documented cases of sulfides from a *PolyGeysers*[®] causing a fish kill. However, when an operational *PolyGeysers*[®] loses power so both the water circulation and the backwashing is disrupted, then the bacteria in the sludge and the biofilm in the bed will rapidly deplete all the oxygen in the filter. Sulfides will be produced and begin to accumulate. When the power restores circulation, sulfide can be smelled for the first minute. The sulfides could potentially cause damages to aquatic species in the receiving tank or pond. So as a precaution: **In cases of prolonged power interruption, divert the initial flush of water away from ponds or tanks containing sensitive aquatic species.**

In summary, sludge digestion does occur in any *PolyGeysers*[®] under organic loading. Under many circumstances sulfides are produced but largely remain in the sludge. It is normal to smell “rotten egg” smell as the sludge is removed from the unit. The smell will dissipate rapidly once the sludge is exposed to oxygen. Sulfides produced in the sludge basin have not been observed to have any impact on waters treated by the units. If an active filter is turned off for more than a couple of hours, the first flush of water should be diverted to avoid the sulfides produced while the unit is incapacitated

Filter Acclimation

The bacterial culture, which grows attached to the beads, performs the biochemical transformations that are so critical in the purification of recycled waters. Initially, the biofilter has no bacteria and the culture must be started. Development of a biofilm layer on the media is required for biofiltration. The process of growing the initial bacterial culture in the biofilter or adjusting an established culture to a change in loading is called “acclimation”. Fortunately, the process of biofilter acclimation is easy. It just takes a little time and food for the bacteria.

The acclimation process is very simple if you have an acclimated bead filter, or other cycled aquaculture system on your premises. Just exchange a few cubic feet of acclimated beads from the old filter with new beads and both filters will adjust rapidly. Lacking the beads, have a friend provide you with media

(from the filter, or tank substrate) from an established, cycled and healthy fish tank. The cycled media will aid the transfer of desirable bacteria into the system to colonize the filter.

One way to acclimate a recirculating system with a biofilter is to add a few hardy fish, turtles, or mollusks to the system. Start off with restricted feeding and gradually increase as the filter develops. Keep in mind; you do not want to add sick fish, or anything that may pose a disease or parasite risk to your future inhabitants.

Bead filters will begin capturing suspended solids immediately because that is primarily a physical process that is not dependent on the development of a biofilm. The biofilm for biological filtration will take a few weeks to develop if it is not introduced into the system via established media. The heterotrophic bacteria will grow rapidly and quickly attach themselves to the beads. The nitrifying bacteria, however, are very slow reproducers and may require almost thirty days under warm water conditions (2 - 3 weeks is more typical) to establish themselves.

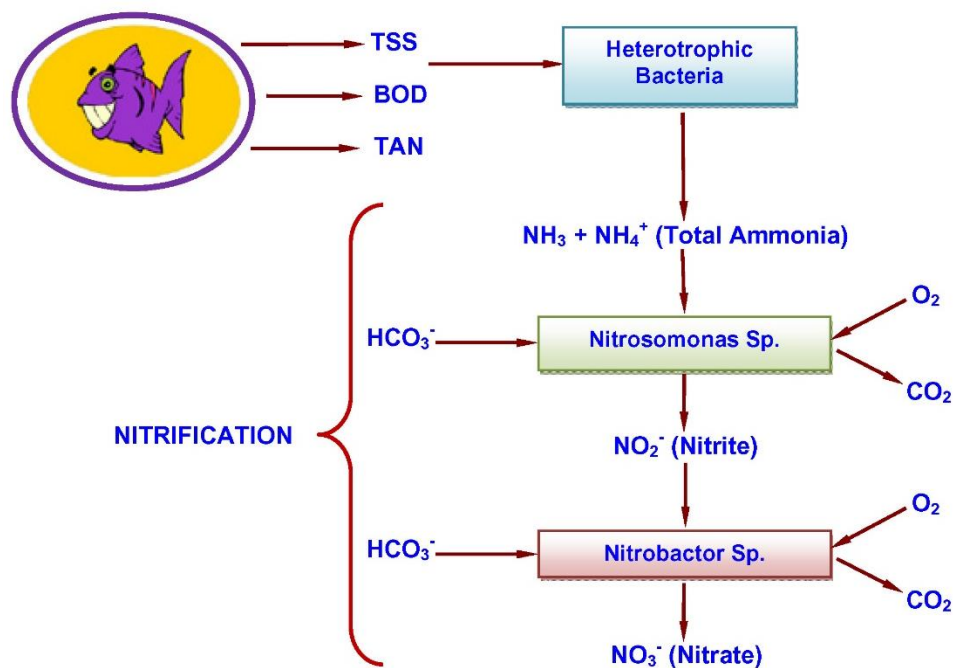

Figure 3 Two specialized types of nitrifying bacteria convert toxic Ammonia and Nitrite to the relatively safe Nitrate. Bicarbonate ions and oxygen are required in large amounts.

During acclimation, the backwash frequency of your *PolyGeyser*® filter should be 1-2 backwashes per day. This will keep the bead mixed and promote homogenous growth of nitrifying bacteria throughout the bead bed.

Figure 4 illustrates the classical pattern of TAN (total ammonia nitrogen) and nitrite concentrations observed during filter acclimation with animals. The process starts with an accumulation of TAN. For a week or two the TAN concentration will steadily increase, then suddenly (typically within 36 hours) the TAN concentration will suddenly drop to near zero levels. This indicates that the AOBs responsible for ammonia conversion to nitrite are present in large numbers. At the same time there will be a sudden rise in nitrite levels, followed by a gradual increase which will continue until suddenly the second group of bacteria, *Nitrobacter*, catch up with their new food supply and the nitrite concentrations plummet. The filter is now considered acclimated to a light loading. This initial stage of acclimation is critical because during this period populations of bacteria which can effectively attack the specific waste produced by the animals become established and these bacterial populations adjust to operate under the water quality conditions and temperature regime found in your system. This unique culture of bacteria will remain in the biofilter for years if maintained.

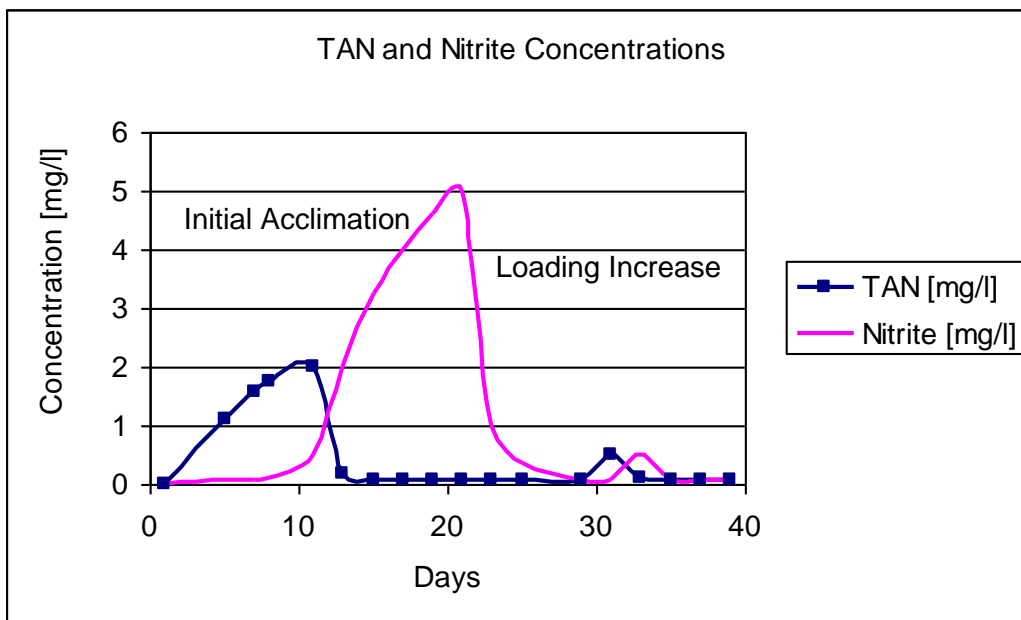

Figure 4. Tan and nitrite concentration build-ups are normally observed during the initial acclimation of a biofilter.

Table 3 summarizes things you can do to accelerate the initial acclimation of the bead filter. These procedures can reduce acclimation time to as little as two weeks in a warm freshwater system. One of the principal limitations of acclimating a filter with animals is that little or no nitrite is available for the growth of NOBs until the AOB population has become established. This means that the very slow growing *Nitrobacter* cannot even get started for over a week. Therefore, you can simply reduce the acclimation time by adding nitrite at the start.

Table 3. Things You can do to Accelerate the Initial Acclimation of a Bead Filter

	Procedure	How does it help?
1	Add sodium nitrite at a concentration of 1 mg-N/l on the first day.	Allows growth of <u>Nitrobacter</u> to start immediately.
2	Add beads or tank substrate from an established biofilter. *	Introduces species/strains of bacteria that are well suited for the bead filter's ecosystem.
3	Reduce Filter Backwash Frequency	Minimizes the loss of biofloc.
4	Raise the temperature of the system to 30°C.	Accelerates bacterial growth rates by increasing metabolic rates.
5	Adjust the pH to 8.0. (Check fish compatibility; otherwise, cycle fishless with chemical additions)	Accelerates bacterial growth rates by increasing ammonia (NH ₃) concentrations.
6	Add sodium bicarbonate to raise the alkalinity to 150 mg-CaCO ₃ /l	Accelerates bacterial growth rates by increasing bicarbonate availability.
* Disease may be spread with the biofilm, so make sure the source is healthy.		

The animals you select to use do not need to be the same as what you will be culturing. The best choice for freshwater systems is turtles. The ammonia and nitrite concentrations that will be reached will not affect these animals. Therefore, you do not have to worry. In-expensive domestic Koi or goldfish are good choices if fish are used. However, it is important that the fish or animals used during acclimation are disease free so as not to infect your high quality fish later. These animals can tolerate **short-term** exposure to TAN and nitrite levels of about 5 mg-N/l without harm if you keep the pH between 7.5 and 8.0 and add some sodium chloride (rock salt) or calcium chloride. Chlorides help prevent nitrite toxicity by blocking nitrite transfer in the gills. The pH range keeps the TAN in the less toxic NH₄⁺ form. It is usually the nitrite peak, which is twice to three times as high as the TAN peak, which damages the fish. If the fish show signs of stress (inactivity, lack of hunger, or gaping near the surface), remove them; you will have plenty of food for the bacteria in the water column already. The fish should be reintroduced into the system once both the TAN and nitrite levels fall below 1 mg-N/l.

Most systems will acclimate in two to three weeks without any problems. Occasionally a system will be “stuck” typically in the nitrite acclimation. The reproduction rates of the NOB's is much slower than the AOB's. The NOBs only reproduce a few times a day. The growth rate of marine NOBs is slower than freshwater NOBs so marine acclimation typically fall in the three to four week range, However, the main reason for delayed acclimation appears to be water temperature. The reproduction rate of an NOB at

15°C is less than half of than at 30°C. During acclimation a few bacteria with the right characteristics for your system must first attach to the media then reproduce through perhaps a hundred generations to reach acclimation. So if you wish to acclimate in a hurry then heat your water to 30°C until the systems then lower the temperature to the desired level for the fish. The bacteria culture will quickly adjust to the lower temperature. And, remember that the characteristic drop in nitrite concentrations when it occurs happens very quickly. It seems like the nitrites will never go down and then suddenly they do.

The initial acclimation assures that the biofilter contains the right type of bacteria. However, you then must adjust the amount of bacteria to assure there are enough of them to process the ammonia produced by the animals in the system. Therefore, the next step in the acclimation process is to increase the density of animals in moderate steps allowing some time for the bacterial population to grow to meet the increased demand. This process of acclimation to increased loading is normally undertaken with the animals of choice, since the TAN and nitrite, peaks are small and quickly disappear. As a general statement, an acclimated filter will completely adjust to a sudden increase in fish density (or feed level) within 72 hours. If the step increase is moderate (< 33 percent of current load), the acclimation will probably occur without noticeable peaks. The heights of the acclimation peaks are actually controlled by the density of fish in the system, not by the size of the biofilter. That is, the nitrite peak in a system with a fish density of 0.25 pounds/gallon will display a peak concentration one-half as high as a system with a density of 0.5 pounds/gallon.

Table 4 summarizes additional methods that can be used to decrease transitional peaks. The process of acclimation to increased loading occurs naturally if the bacteria and animals are allowed to grow together. The bacteria always grow faster, maintaining the proper balance between the biofilm and the animal density. For example, within a Koi pond, once the filter is acclimated to the fingerling density, the biofilter's ecosystem will take over and maintain the proper balance. Your management responsibility occurs when the natural growth processes are disrupted by sudden (unnatural) changes in the system.

Table 4. Things that Can be Done to Decrease Transitional Peaks of TAN and Nitrite When the Animal Density or Feed Rates are Increased

	Procedure	How does it help?
1	Increase your water until the biofilter adjusts.	TAN and nitrite will be flushed with the water.
2	Discontinue or reduce feed rate during the transition.	TAN excretion rates from most animals increases with feeding.
3	Make loading increases in small increments (< 33 percent of current load) and separate steps by about 3 days.	Existing bacteria will absorb most of the increased load and reproduce rapidly.
4	Extend backwashing interval.	Decreases biofloc loss during the critical transition.

5	Adjust pH and alkalinity to optimum range.	Accelerates reproduction of nitrifying bacteria.
6	Artificially increase the TAN loading prior to the increase by dosing of ammonia chloride (NH ₄ Cl) and sodium nitrite (NaNO ₂) to a level of 1 mg-N/l.	Promotes growth of the critical nitrifying bacteria, enriching their density in the biofilm.

Appendix A: The Science behind Bioclarification

The term “Bioclarification” was coined some years ago by Dr. Ronald F. Malone, the inventor and patent holder of Bead Filter Technologies, to describe the ability of bead filters to perform both mechanical and biological filtration in the same unit. The ability of bead filters to perform these tasks is described in detail below.

Clarification

Bead filters perform well in the control of suspended solids across a broad spectrum of conditions. Bead filters capture solids through four identifiable mechanisms (Table 1). With the exception of adsorption, the solids capture mechanisms are physical in nature and are common to all types of granular media filters. As a general observation, the filters seem to control fine colloidal particles best with some biofilm development. This suggests that the biofilm absorption process is an important mechanism in the control of fine suspended solids and thus water clarity. Studies have shown that bead filters capture 100% of particles > 50 microns and 48% of particles in the 5-10 micron range per pass (Figure 1).

Table 1. Mechanisms Contributing to the Capture of Solids in a Bead Filter

Mechanisms	Comment
Straining	Direct capture of larger particles as they pass into small openings between the beads.
Settling	Sinking of suspended solids onto the surface of the beads.
Interception	Impact of particles directly onto the surface of a bed.
Adsorption	Small particles are captured and absorbed into the sticky biofilm.

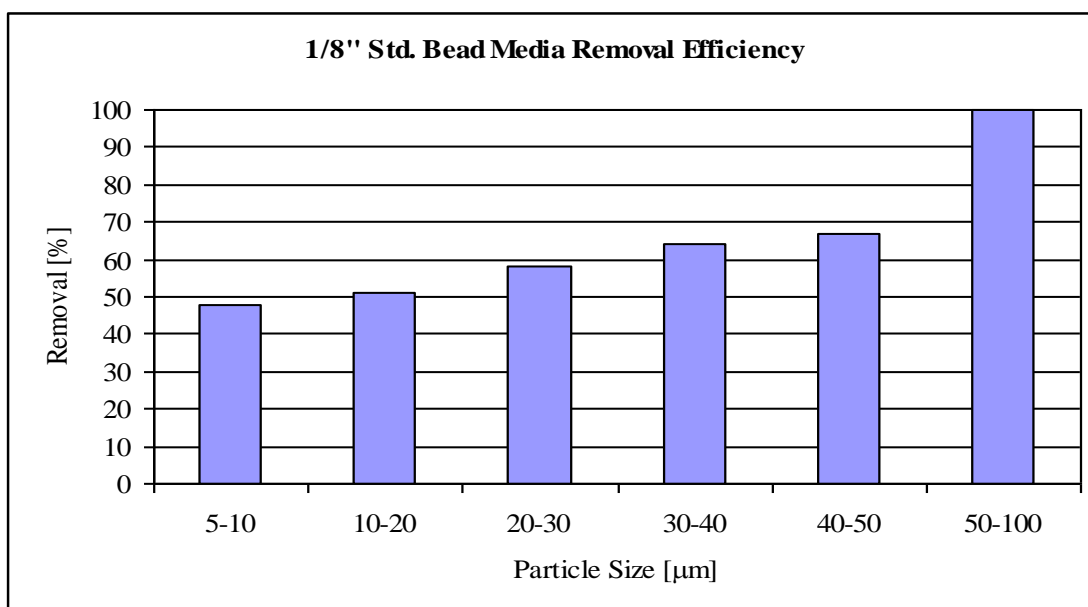

Figure 1. All particles above 50 microns are removed in the first pass through the filter and the remainders are removed with multiple passes.

The flowrate delivered to a bead filter is the principle management factor influencing suspended solids removal. The efficiency (single pass percent reduction in TSS) of a bead filter generally increases as the flowrate to the filter decreases; however, the capture rate (mass of TSS captured) tends to increase with flowrate. This apparent contradiction occurs because per pass efficiency is relatively insensitive to changes in flowrate, and so, minor drops in efficiency that occur with flow increases are more than compensated for by enhanced solids transport to the filter. Generally, recirculating rates used with closed or partially recycled systems should be maximized to obtain the lowest possible TSS level in the holding tanks.

Separation of captured solids from the bead bed is accomplished by sedimentation of released sludge after the bed is backwashed. Materials such as fats or wood chips merely float upward with the beads and are not removed. In sufficient quantity, these materials will eventually foul the bed requiring media replacement. Bead filters are also not well suited for the clarification of waters suffering from mineral turbidity problems caused by fine clays or other colloidal particles. Lacking good biofilm development, the mechanisms for the capture efficiencies are unacceptably low. Finally, the bead filters will impact but cannot control planktonic algal blooms. Although some capture occurs as a general rule, the algae can grow faster than they can be caught and thus little progress towards clarification is made. Application of the bead filter technology to the problem of colloidal mineral turbidity or algal blooms requires the use of supplemental treatments (chemical flocculation or U.V. disinfection, respectively) or the filter will be ineffective.

Biofiltration

In the biofiltration mode, bead filters are classified as fixed film reactors. Each bead (Figure 2) becomes coated with a thin film of bacteria that extracts nourishment from the wastewater as it passes through the bed. There are two general classifications of bacteria, heterotrophic and nitrifying, that are of particular interest (Table 2). The two bacteria co-exist in the filter, and understanding their impact on each other as well as on the filter is critical.

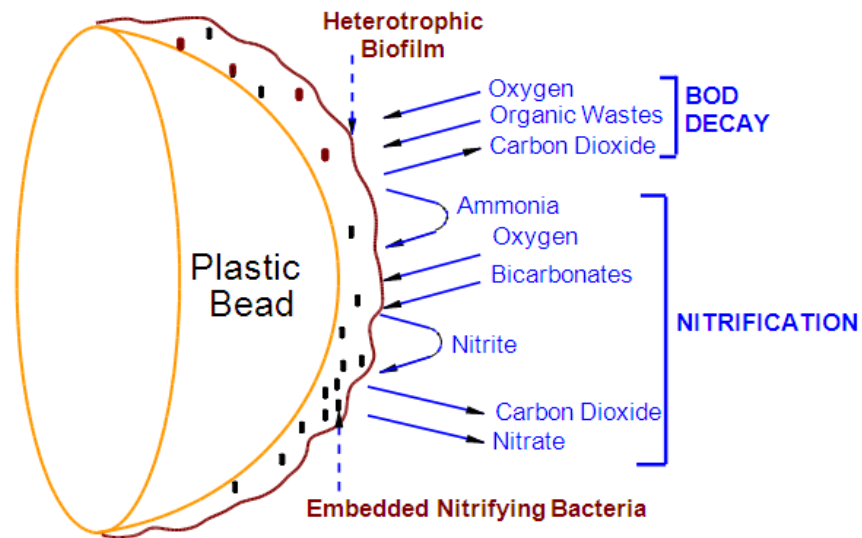

Figure 2. The bacterial film that coats each bead contains the nitrifying bacterial population. Heterotrophic bacteria also form a thin biofilm layer on each bead. The nitrifying bacteria compete with the heterotrophic bacteria for space.

Table 2. In the Biofiltration Mode, Bead Filters Cultivate Two Types of Bacteria which Perform the Critical Biofiltration Function.

	Heterotrophic Bacteria	Nitrifying
Function	Remove dissolved organics (BOD) from the water column; breakdown and decay organic sludges.	Convert toxic ammonia and nitrite to nitrate.
Reproduction Rate	Very fast (10 – 15 minutes)	Slow (12 – 36 hrs)
Yield (mg bacteria/mg waste consumed)	0.6 – 0.8	0.05 – 0.10
Bead adhesion	Poor	Good

The classification of heterotrophic bacteria encompasses a great number of genera/species that share the common characteristics of extracting their nourishment from the breakdown (decay) of organic matter. Biochemical oxygen demand (BOD) is largely an indirect measure of the biodegradable organic material in water. Heterotrophic bacteria reduce BOD levels, consuming oxygen in the process. About 60 percent of the organic matter consumed is converted to bacterial biomass; whereas, the balance (40 percent) is converted to carbon dioxide, water, or ammonia. Heterotrophic bacteria grow very fast, capable of doubling their population every ten to fifteen minutes. If the BOD in the water being treated is very high (> 20 mg-O₂/l), the heterotrophs will quickly dominate the bead bed, overgrowing the slower growing nitrifying bacteria and consuming tremendous amounts of oxygen.

The second, yet more important, classification of bacteria is the nitrifying bacteria. These bacteria are specialists, extracting energy for growth from the chemical conversion of ammonia to nitrite and from nitrite to nitrate. Nitrate is a stable end product which, although a valuable nutrient for plants, displays little of the toxic impacts of ammonia and nitrite. Previously the principle nitrification genera thought responsible for the oxidation of ammonia and nitrite were of the genera *Nitrosomonas* and *Nitrobacter*, respectively. However DNA testing has reveal a much broader participation in the nitrification process so they are now referred to as Ammonia Oxidizing Bacteria (AOB) and Nitrite Oxidizing Bacteria (NOB). All nitrifying bacteria are very slow growing and sensitive to a wide variety of water quality factors. It is not surprising that most bead filters used for biofiltration are managed to optimize conditions for nitrification.

Figure 3 simplifies the complex degradation processes that occurring a recirculating aquaculture system. The free ammonia (NH₃) is excreted directly by fish or produced by the heterotrophic bacteria that breakdown the proteins in the organic solids excreted by the fish. The ammonia will interact with the

hydrogen ions (H^+) in the water to form the ammonium ion (NH_4^+) and the combination ($NH_3+NH_4^+$) it referred to as Total Ammonia Nitrogen or TAN. Although only the free ammonia is toxic to fish, it is the TAN concentration that controls the bacterial conversion rates. The heterotrophic bacteria initiate the degradation process by attaching the hydrogen and carbon bonds that characterize and organic waste. This an oxidation step that releases ammonia whenever a nitrogenous compound is encounters. Heterotrophic bacteria use oxygen and release carbon dioxide, but, have little effect pH or the bicarbonates in the system. The AOBs in system then initiate the first step in the nitrification process by the oxidation of TAN to nitrite. This process consumes both oxygen and bicarbonates while producing Nitrite and carbon dioxide. The second groups of nitrifying bacteria, the NOBs, then oxidize the Nitrite to the non-toxic Nitrate (NO_3^-).

LIMITED WARRANTY

Aquaculture Systems Technologies, LLC, (AST) warrants the material and workmanship to be free of defects under designated use and normal service on its **High Pressure PolyGeyser® Bead Filters** for a period of one (1) year from the date of shipment. All warranty claims must be presented in writing to AST. Normal use and service requires the following:

1. The filter must be installed and operated according to the installation and operational instructions supplied by the manufacturer.
2. Excessive weight due to heavy pipes, valves, etc. must not be carried by the inlets or outlets.
3. The filter hull pressure must never exceed the maximum pressure rating of 10 psi as specified by the manufacturer.

This warranty applies only to the original purchase price, and is good only when the total payment for the equipment has been received. The limited warranty (expressed or implied) during the warranty period shall consist of the repair or replacement of the items of manufacture, at the discretion of **AST**, and said warranty applies only to the original purchaser. This warranty is void if the items are damaged by negligence or accident after purchase; used for other than the intended purpose; altered; repaired at other than an authorized service center; or used with other items that affect the integrity, performance, or safety of these items. Liability does not cover indirect or consequential cost, including materials lost, labor or installation/reinstallation cost, injury, property damage, or damages caused by mishandling. Returns for repairs must be pre-approved and the return authorization number prominently displayed on the outside of the shipping container. Returns will not be accepted without a “return authorization number”. Returns for repair should be sent to the following address “FREIGHT PREPAID”:

AST- Aquaculture Systems Technologies, LLC

108 Industrial Ave.

New Orleans, LA 70121

Manufacturer’s liability for incidental or consequential damages is specifically excluded to the full extent permitted by the applicable law. This warranty gives you specific legal rights, and you may also have other rights, which may vary from state to state.

THIS WARRANTY IS EXCLUSIVE OF ALL OTHER IMPLIED WARRANTIES INCLUDING MERCHANTABILITY AND FITNESS FOR A PARTICULAR PURPOSE.

